

MFJ

IntelliTuner™ *Automatic Antenna Tuner*

Model MFJ-993B



INSTRUCTION MANUAL

CAUTION: Read All Instructions Before Operating Equipment

MFJ ENTERPRISES, INC.

300 Industrial Park Road
Starkville, MS 39759 USA
Tel: 662-323-5869 Fax: 662-323-6551

DISCLAIMER

Information in this manual is designed for **user purposes only** and is *not* intended to supersede information contained in customer regulations, technical manuals/documents, positional handbooks, or other official publications. The copy of this manual provided to the customer will *not* be updated to reflect current data.

Customers using this manual should report errors or omissions, recommendations for improvements, or other comments to MFJ Enterprises, 300 Industrial Park Road, Starkville, MS 39759. Phone: (662) 323-5869; FAX: (662) 323-6551. Business hours: M-F 8-4:30 CST.

Contents

THE BASICS

Introduction.....	1
Features.....	2
Specifications.....	2
Fast Start.....	3
Front Panel.....	4
SWR/Wattmeter.....	4
LCD Display.....	5
LCD Contrast Control.....	5
ANT Button.....	5
MODE Button.....	5
C-UP and C-DN Buttons.....	5
L-UP and L-DN Buttons.....	5
AUTO Button.....	5
TUNE Button.....	6
<i>StickyTune</i> [™]	6
VOL Control.....	6
POWER Button.....	6
Back Panel.....	8
Power.....	8
Remote Port.....	8
Radio Interface.....	8
Transmitter.....	11
Ground.....	11
Balanced Line.....	11
Wire.....	11
Antenna 1.....	11
Antenna 2.....	11
Installation.....	11
SWR/Wattmeter.....	12

THE MENUS

Main Mode Menus.....	13
Digital Wattmeter Menu.....	13
Power Bar Meter Menu.....	13
SWR Bar Meter Menu.....	14
L-Network Menu.....	14
Tuner Indicators.....	15
Antenna.....	15
IntelliTune.....	15
Memory.....	15
Power Level.....	15
LC Limit.....	16

Meter Range.....	16
Auto/Semi	16
StickyTune.....	16
Setup Mode Menus	17
Power Level Menu.....	17
Target SWR Menu.....	17
Auto Tune SWR Menu	18
Meter Range Menu	18
Peak Hold Menu	18
Memory Menu	18
IntelliTune Menu	19
SWR Beep Menu	20
Beep Menu.....	20
Refresh Menu.....	20
Power-On Reset (POR) Sticky Tune Menu	20
LC Limit Menu	20

OPERATION

Manual Tuning.....	21
Meter Codes and Audible Beeps.....	21
Transceiver Foldback.....	23
Grounding Hints	23
Antenna System Hints.....	24
Coaxial Cable Selection.....	24
Location	24
Matching Problems	25

APPENDICES

Resetting the Tuner.....	26
Factory Defaults.....	26
Delete Antenna Memory.....	27
Total Reset	27
Self Test	27
Power Down Circuit Test.....	29
Relay Test	29
Firmware Version Number via Meter.....	29
Setting the Speaker Volume.....	30
Wattmeter Calibration.....	30
SWR Bridge Calibration	30
Frequency Counter Calibration.....	31
Alinco Radio Interface.....	32
Connections	32
Operation	32
Icom Radio Interface.....	33
Connections	33
Operation	33
Kenwood Radio Interface	34
Connections	34

Operation	34
Yaesu Radio Interface/MFJ-5124Y	35
Connections for FT-100.....	35
Operation for FT-100.....	35
Connections for FT-450.....	36
Operation for FT-450.....	36
Connections for FT-857 or FT-897.....	37
Operation for FT-857 or FT-897.....	37
Connections for FT-950.....	38
Operation for FT-950.....	38
Yaesu Radio Interface/MFJ-5124Y2	39
Connections for FT-847.....	39
Operation for FT-847.....	39
Yaesu Radio Interface/MFJ-5124Y3	40
Connections for FT-1000MP series of radios.....	40
Operation for FT-1000MP series of radios.....	40
Connections for FTDX-9000 series of radios.....	40
Operation for FTDX-9000 series of radios.....	41
Yaesu Radio Interface/MFJ-5124Y4	41
Connections for FT-2000 series of radios.....	41
Operation for FT-2000 series of radios.....	42
Connections for FTDX-5000 series of radios.....	42
Operation for FTDX-5000 series of radios.....	42
In Case of Difficulty	43
Technical Assistance.....	43
List of Accessories.....	43
Circuit Block Diagram.....	44

FIGURES

Figure 1. Typical Installation Block Diagram	4
Figure 2. MFJ-993B Front Panel	4
Figure 3. Mode Button Flow Chart and Button Action	7
Figure 4. MFJ-993B Back Panel.....	8
Figure 5. Alinco Interface Cable.....	9
Figure 6. Icom Interface Cable	9
Figure 7. Yaesu Interface Cable (FT-1000MP/-9000 series).....	10
Figure 8. Yaesu Interface Cable (FT-2000/-5000 series).....	10
Figure 9. SWR/Wattmeter	12
Figure 10. Power Bar Meter (High Range).....	14
Figure 11. Power Bar Meter (Low Range)	14
Figure 12. SWR Bar Meter	14
Figure 13. Main Mode Menus Display	15
Figure 14. Tuner Indicators.....	16
Figure 15. Power-On Operations	26
Figure 16. MFJ-993B Circuit Block Diagram	44

TABLES

Table 1. Memory Resolution	19
Table 2. Meter Needle Stationary Codes	22
Table 3. Meter Needle Bounce Codes	23
Table 4. Failure Messages.....	28

The Basics

Introduction

The MFJ-993B *IntelliTuner*[™] lets you rapidly tune unbalanced, balanced, or single-wire antenna automatically. The MFJ-993B is a comprehensive automatic antenna tuning center with SWR/wattmeter, antenna switch for two antennas, and a 4:1 current balun for balanced lines.

MFJ's exclusive *InstantRecall*[™], *IntelliTune*[™] and *AdaptiveSearch*[™] algorithms give you fast automatic tuning with more than 20,000 non-volatile *VirtualAntenna*[™] memories. Each of the two antennas has four banks of memory; each memory bank has over 2500 non-volatile memories for tuner settings.

The MFJ-993B *IntelliTuner*[™] includes a highly efficient switching L-network with wide matching capability, 1.8 to 30 MHz coverage, cross-needle power meters, backlight LCD display, an accessory remote control port, a radio interface port, and heavy-duty 16 amp/1000 volt relays. It is rated at 300 watts to match 6 to 1600 ohms antennas (SWR up to 32:1) or 150 watts to match wider range of 6 to 3200 ohms (SWR up to 64:1).

A maximum of 256 values of inductance and 256 values of capacitance are available. With the capacitance switched between the input and output side, this provides a total of 131,072 L/C tuning combinations. The nominal tuning ranges are 0 to 24 μ H and 0 to 3900 pF.

The MFJ-993B *IntelliTuner*[™] learns and remembers. When you transmit, it automatically adjusts for minimum SWR and remembers the frequency and tuner settings, safely stored in non-volatile memory. The next time you operate on that frequency (or close to it) and antenna, the tuner settings are instantly restored and you're ready to operate in milliseconds. Each of two antenna selections has four banks of memory, which can learn and remember more than 2500 frequencies and tuner settings per bank.

When you key your transmitter, MFJ's *InstantRecall*[™] checks its memory to see if you have operated on that frequency before. If so, tuning is instantaneous and you're ready to operate. If not, MFJ's *IntelliTune*[™] algorithm (based on MFJ's famous SWR Analyzer technology) kicks in. It measures the complex impedance of your antenna. Next, it calculates the components it needs and instantly snaps them in. Finally, it fine-tunes to minimize SWR, and you're ready to operate – typically in a fraction of a second.

If the antenna impedance is not within the tuner's measurement range, MFJ's *AdaptiveSearch*[™] algorithm goes into action. Frequency is measured and relevant components values are determined. Only those values are searched for fast tuning. If it still cannot find a match, the search is performed again using a different search pattern.

The target tuned SWR can be set to 1.0 to 2.0. The minimum power to tune is approximately two watts, with maximum SWR tuning accuracy occurring at tuning power levels of 10-20 watts. Manual tuning is also available for "touching up" the tuning if desired.

Like all MFJ's *IntelliTuners*[™], the MFJ-993B supports radio tuner interfaces that are compatible with Alinco EDX-2 tuner, Icom AH-3 and AH-4 tuners, Kenwood AT-300 tuner, Yaesu FC-30 tuner, certain Yaesu radios with a CAT system, and Yaesu FH-1 and FH-2 remote controls. Optional interface cables MFJ-5124A (for Alinco), MFJ-5124I (for Icom), MFJ-5124K (for Kenwood), and MFJ-5124Y/Y2/Y3/Y4 (for Yaesu) are available from MFJ Enterprises, Inc. The optional MFJ-993RC Remote Control provides most tuner controls, allowing convenient remote locating of the tuner itself.

The MFJ-993B tuner enters a “sleep” mode when idle and when no transmit signal is present, turning off the microprocessor clock to avoid the generation of spurious signals.

Features

- Automatically matches antennas with impedances of 6 to 1600 ohms or 6 to 3200 ohms
- Handles 300 watts (match 6 to 1600 ohms) or 150 watts (match 6 to 3200 ohms)
- Tunes in less than 15 seconds, usually less than 5 seconds
- Over 20,000 non-volatile memories for tuner settings
- Four memory banks per antenna with over 2500 memories per bank
- Highly efficient switching L-network matching circuit
- 1.8 to 30 MHz continuous frequency coverage
- Adjustable target SWR 1.0 to 2.0 (default is 1.5)
- Adjustable SWR threshold 0.5 to 1.5 (default is 0.5 above target SWR)
- Lighted cross-needle SWR/wattmeter with high, low, and auto range options
- Multifunction backlit LCD display with contrast control
- Numeric readings for SWR, forward and reflected power
- Bar meters for SWR, forward and reflected power with range options
- Audio SWR meter with volume control
- Built-in frequency counter for remembering frequency-specific matching values
- Two SO-239 coax fed antenna connectors
- Connector for random wire or single wire antennas
- Built-in 4:1 current balun for balanced line antennas
- Optional remote control
- Optional radio interface cables for compatible radios

Specifications

- Impedance matching range : 6 to 1600 ohms (300 watts) or 6 to 3200 ohms (150 watts)
- SWR matching range : Up to 8:1 for < 50 ohms and up to 32:1 for >50 ohms (300 watts)
Up to 8:1 for < 50 ohms and up to 64:1 for >50 ohms (150 watts)
- Minimum power for tuning : 2 watts (optimum SWR tuning accuracy occurs at 10-20 watts)
- Maximum power while tuning : 100 watts with foldback, 20 watts without foldback
- RF power limit : 300 watts SSB/CW
- Frequency range : 1.8 to 30 MHz continuous coverage
- Frequency counter accuracy : ± 1 kHz across HF bands
- Capacitance range : 0 to 3908 pF nominal (256 values)
- Inductance range : 0 to 24.86 μ H nominal (256 values)
- Relay rating : 16 amp 1000 volts
- Relay electrical life : 100,000 operations
- Relay mechanical life : 10 million operations
- Memory endurance : 1 million erase/write cycles
- Memory data retention : > 200 years
- Power supply requirements : 12 - 15 volts DC
- Current consumption : 1 amp or less
- Dimensions (connectors not incl.) : 10.1 \times 2.8 \times 9.2 in; 257 \times 71 \times 234 mm (w \times h \times d)
- Weight : Approx. 3.9 lb; 1.77 kg

† Specifications and design are subject to change without notice.

Fast Start

WARNING

- **Never operate the tuner with its cover removed. Contact with the components inside the tuner while transmitting will result in painful RF burns.**
- **Locate the tuner so that the rear terminals are *not accessible* during operation. The single wire and balanced line connection may have high voltage while transmitting.**
- **Disconnect all antennas from the tuner during lightning storms.**
- **Always tune with low power (2 watts minimum, 10-20 watts recommended), and with any in-line amplifier bypassed. Apply maximum power only after tuning up.**
- **Never exceed tuner specifications.**

1. Connect the MFJ-993B to a 12-15 VDC voltage source capable of supplying at least 1 amp.
2. Connect your transmitter or amplifier output to the TRANSMITTER connector using a 50-ohm coaxial cable.
3. Connect your coax-fed antenna to the ANTENNA 1 connector using a 50-ohm coaxial cable, or connect your random wire to the WIRE binding post, or connect your balanced line antenna to the BALANCED LINE binding posts and connect a jumper between the other two posts as indicated.
4. Connect your ground connection to the GROUND post.
5. Press the [POWER] button to turn on the MFJ-993B tuner. The Power-On Reset default is also for *StickyTune™* to be ON. Place the [ANT] button in the out position to select antenna 1.

Note: *StickyTune™ after power cycle means that the MFJ-993B will do a full tune after a power cycle on the first frequency you transmit on only. No other frequency or memory solutions will be affected. So you can fully re-tune on any frequency by simply cycling power.*

6. Lock the [AUTO] button in to select semi-automatic mode.

Note: *The AUTO button should always be IN (semi-automatic) unless a compatible radio interface cable is connected between the MFJ-993B and your transceiver. This ensures that the MFJ-993B does not attempt tuning during high-power operation, and is particularly important when an HF amplifier is in-line.*

Note: *If an amplifier is in-line, it should always be bypassed prior to tuning.*

7. Key your transmitter to output a carrier of 2-20 watts CW, FM or AM.

Note: *Due to detector non-linearities at low power levels, best SWR tuning accuracy occurs at 10-20 watts.*

8. Press and hold the [TUNE] button for one second to start the automatic tuning process. When completed, check to ensure an SWR of 1.5 or less has been achieved before increasing RF power.

Note: *If you have a tuning solution on one band or antenna and you then change bands or antenna and attempt to transmit a tuning signal, the previous tuning solution may be sufficiently severe such that no power is detected by the MFJ-993B (the MFJ-993B will tell you to increase power). When this occurs, simply bypass the MFJ-993B and then initiate a tune.*

Note: If the tuner was unable to achieve the target SWR, the Reflected Power needle will bounce three times when tuning completes.

9. You are ready to transmit with full power.

Note: During the automatic tuning process, the tuner will make some noise. These are the relays switching at a very high rate and this is normal. Do not be alarmed.

Note: When the tuner power is OFF, the tuner is bypassed and RF from the transmitter or amplifier goes directly to the antenna with no matching. The MFJ-993B always powers up in bypass mode to ensure maximum receiver sensitivity if you are listening on a different frequency than where tuning last occurred. When tuning starts, the MFJ-993B reverts to previously stored matching values or finds a new match if no previous information is in memory. You may bypass the tuner at anytime when the tuner power is ON by pressing [C-DN] and [L-DN] simultaneously or pressing [TUNE] quickly. When the MFJ-993B is bypassed, the reflected meter needle bounces to the 20-watt mark while the switches are pressed.

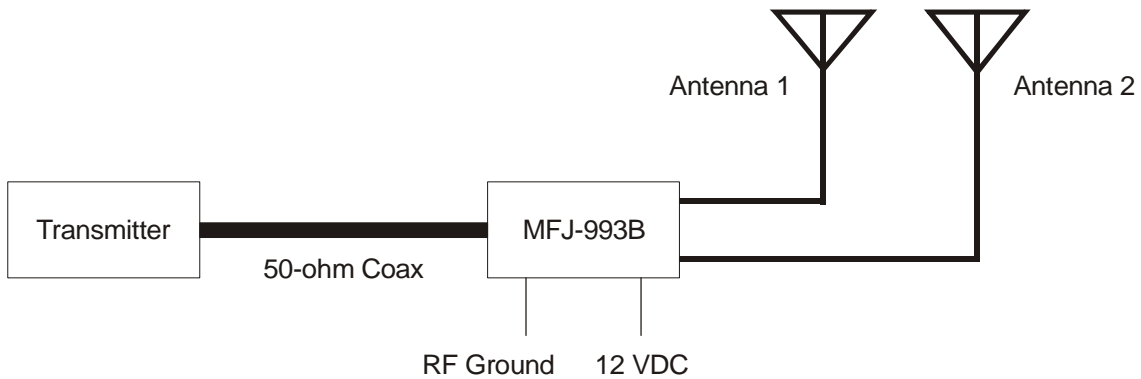

Figure 1. Typical Installation Block Diagram.

Front Panel

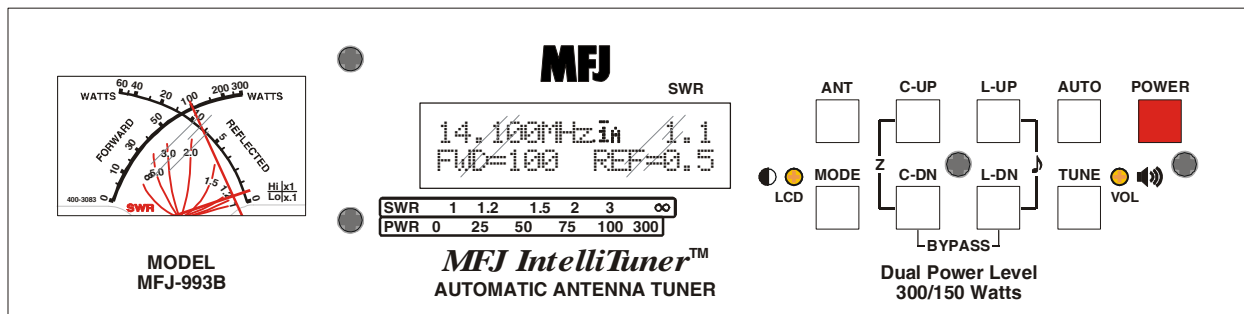

Figure 2. MFJ-993B Front Panel.

- **SWR/Wattmeter:** The cross-needle meter measures forward power, reflected power, and SWR. It operates whenever the MFJ-993B is powered on. The default full-scale readings are 300 watts forward and 60 watts reflected power. The meter can be set to a low power range of 30 watts forward and 6 watts reflected, or AUTO metering where the meter range is determined by the transmit power.

The SWR is measured at the point where the two needles cross. See “SWR/Wattmeter” on page 12 for more detailed information.

- **LCD Display:** A 2-line by 16-character alphanumeric display. It displays the tuner’s various menus and status. The display contrast can be adjusted by the [LCD] control on the front panel. Below the display are the SWR and power bar meter scales. Refer to Figures 13 and 14 for descriptions of the various displayed information.
- **LCD Contrast Control:** A trimpot control that adjusts the contrast of the LCD display. Use a small flat blade screwdriver and turn clockwise to increase contrast.
- **ANT Button:** Used to select the antenna to tune. Button *out* selects Antenna 1; button *in* selects Antenna 2. The Antenna indicator on the main display indicates the selected antenna. A balanced feedline or a single-wire antenna is, by default, Antenna 1. Changing the [ANT] button will switch the antenna *only* when there is no RF power; also, the tuner setting for the selected antenna, if available, is instantly restored from memory when enabled.
- **MODE Button:** Time-sensitive and used to navigate through the various main menus and to enter or exit the setup menus.
- **C-UP and C-DN Buttons:** Used to manually increase or decrease the capacitance of the L-network matching circuit. The capacitance range is 0 to 3908 pF (picofarads). The upper limit of capacitance, dependent on frequency, is used to limit the maximum voltage and current across the tuner’s components. This limit can be removed in the LC Limit setup menu, but is not recommended.

Note: Pressing [C-UP] and [C-DN] simultaneously toggles the capacitor between the input and output sides of the L-network. Forward needle bounces to the 30 watts when the capacitor is on the transmitter side. Reflected needle bounces to the 5 watts when the capacitor is on the antenna side.

- **L-UP and L-DN Buttons:** Used to manually increase or decrease the inductance of the L-network matching circuit. The inductance range is 0 to 24.86 μ H (microhenries). The upper limit of inductance, dependent on frequency, is used to limit the maximum voltage and current across the tuner’s components. This limit can be removed in the LC Limit setup menu, but is not recommended.

Shortcut: Press both [L-UP] and [L-DN] buttons simultaneously to toggle SWR Beep on and off. See “SWR Beep Menu” on page 20.

Note: Pressing [C-DN] and [L-DN] simultaneously places the tuner in bypass mode. The reflected meter needle momentarily bounces to the 20-watt mark to indicate this. RF from the transmitter goes directly to the antenna with no matching.

- **AUTO Button:** Used to select automatic or semi-automatic tuning mode. Button *out* selects automatic mode – the tuning routine is automatically started when 2-10 watts of power is applied and the SWR is a preset amount above the preset target SWR. Button *in* selects the semi-automatic mode – the tuning routine starts only when the [TUNE] button is pressed for 0.5-2 seconds. The Auto/Semi indicator on the main display indicates the selected mode.

Note: During the automatic tuning process, the tuner will make some noise. These are the relays switching at a very high rate and this is normal. Do not be alarmed.

- **TUNE Button:** Has three different functions based on the length of time you press and hold it before releasing. Press [TUNE] quickly (less than 0.5 second) to bypass the tuner. RF from the transmitter goes directly to the antenna with no matching.

Press and hold [TUNE] for 0.5-2 seconds to start the automatic tuning process. The transmitter must be keyed first with at least two watts of power. When the SWR is already below the target SWR, pressing [TUNE] will fine-tune the match for a lower SWR if possible.

StickyTune[™] allows for one-handed tuning operation. Normal tuning requires keying the transmitter with one hand and using the other hand to push the [TUNE] button to start the tuning process unless a transceiver interface cable is installed. When *StickyTune*[™] is enabled, a bar appears on top of the Auto/Semi indicator and the tuning process starts automatically when the transmitter is keyed with at least two watts of power regardless of the SWR. This works in both automatic and semi-automatic modes. To toggle the *StickyTune*[™] mode on and off, press and hold the [TUNE] button for two seconds. The reflected power needle goes to 60-watt mark when on and to 5-watt mark when off; one beep indicates on and two beeps indicate off. Power-On Reset (POR) *StickyTune*[™] mode is selected via the “POR Sticky Tune” setup menu; default is ON after a power cycle.

Note: *StickyTune*[™] is disabled after tuning.

Note: *StickyTune*[™] after power cycle means that the MFJ-993B will do a full tune after a power cycle on the first frequency you transmit on only. No other frequency or memory solutions will be affected. So you can fully re-tune on any frequency by simply cycling power.

Note: If an amplifier is in-line, it should always be bypassed prior to tuning.

- **VOL Control:** A trimpot control that adjusts the volume level of the audio SWR meter. Use a small flat blade screwdriver and turn clockwise to increase volume level.
- **POWER Button:** Used to turn the power on and off. Note that during power-on the analog meter bounces three times (to indicate the model number, 993). When the power is off, the tuner is bypassed (straight through from TRANSMITTER to ANTENNA1 and WIRE). When turning on the power, the tuner powers-up bypassed, but will revert to the last stored matching values or begin tuning on application of RF power when the TUNE button is pressed – or if Automatic or Sticky-Tune is enabled. The target SWR appears on the main screen.

WARNING: Do not turn the power on and off rapidly, otherwise the tuning setting memory can be corrupted and the unit will have to be reset to factory defaults.

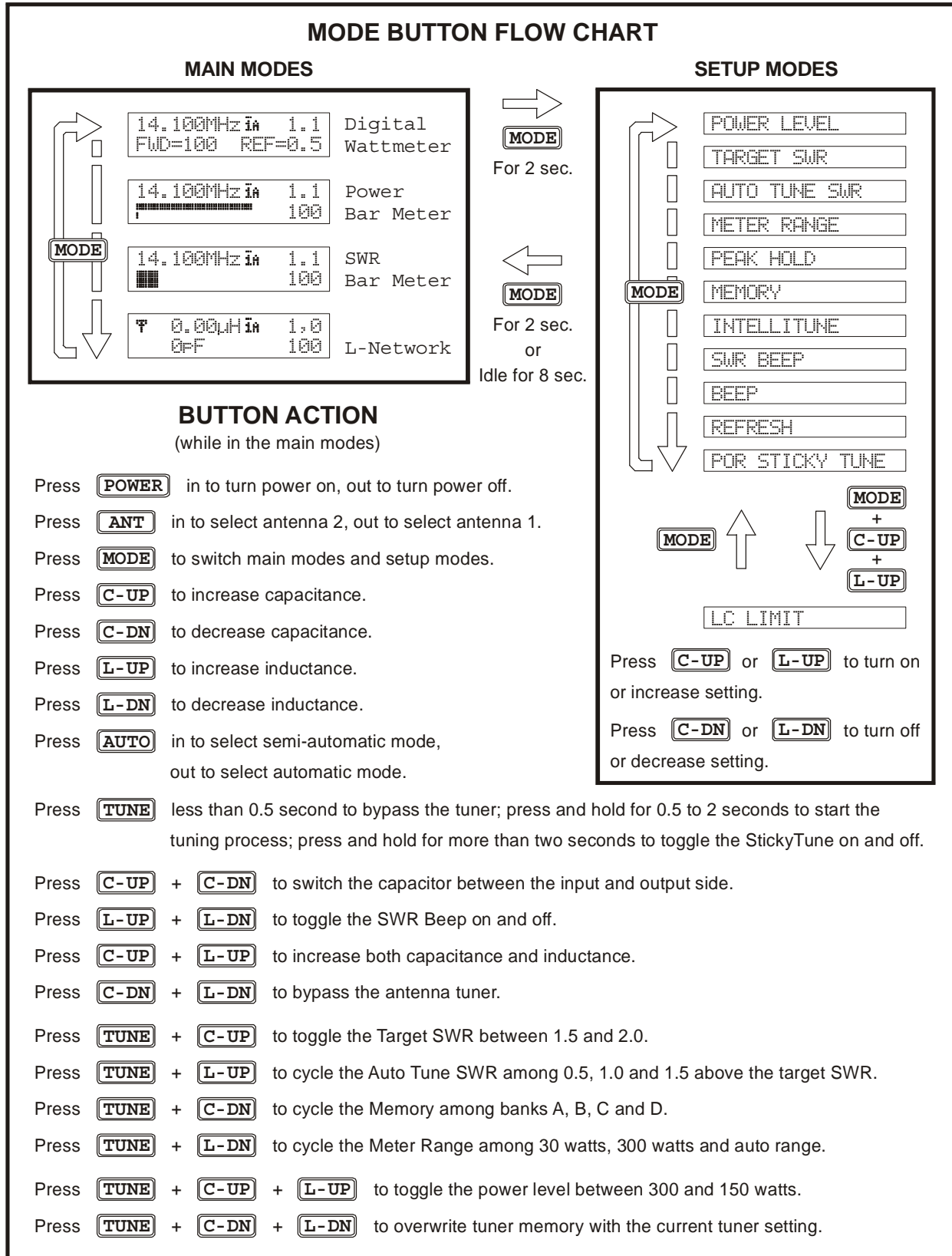

Figure 3. Mode Button Flow Chart and Button Action.

Back Panel

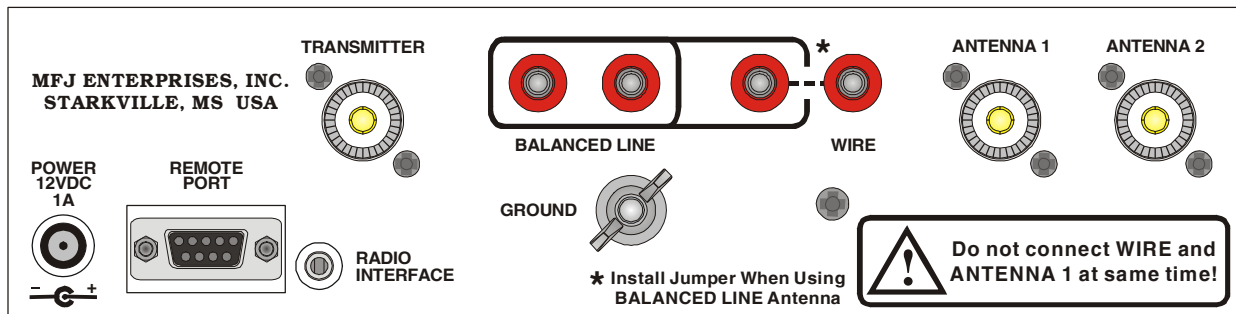

Figure 4. MFJ-993B Back Panel.

- Power:** This jack accepts a standard 2.1 × 5.5 mm coaxial plug with positive center and negative sleeve. The tuner requires 11-15 volts DC at up to 1 amp. The use of a regulated supply is not mandatory but is recommended for best performance. An optional 12 volts DC 1.5 amp power supply, the MFJ-1316, is available from MFJ Enterprises, Inc.

WARNING: Do not apply voltages greater than 18 volts to this unit, or permanent damage may result.

Note: When the tuner power is OFF, the tuner is bypassed and RF from the transmitter goes directly to the antenna (ANTENNA 1) with no matching. When turned on, the tuner powers up in bypass mode.

- Remote Port:** A female DB-9 connector for connecting to the MFJ-993RC Remote Control, allowing remote operation of the tuner. The MFJ-993RC duplicates all the front panel buttons except [POWER] and [MODE]. In addition, there are two LEDs on the remote control. The red Tuning LED lights to indicate tuning is in progress and the green SWR LED lights when the SWR is below the target SWR.

Note: To use the MFJ-993RC remote control, both the [ANT] and [AUTO] buttons on the MFJ-993B automatic tuner must be locked in; otherwise, Antenna 1 and Automatic mode are selected.

- Radio Interface:** A 3.5 mm stereo phone jack for connecting to the tuner interface connector of compatible radios. Most radios provide +13.8 VDC power through the tuner interface connector. If separate power supplies are used to power the MFJ-993B, the MFJ-993B should be powered on first (for certain radios, TURN ON RADIO will display and both needles will bounce) so the radio knows an external tuner is attached. The radio will disable its internal tuner if it has one, and use the MFJ-993B external tuner.

The Radio Interface works with radios that are compatible with Alinco EDX-2, Icom AH-3 and AH-4, Kenwood AT-300, and Yaesu FC-30, FH-1 and FH-2. When connected to a compatible radio, simply press the [TUNER] or [AT] button on the radio; for FH-1 or FH-2 compatible Yaesu, press the [TUNE] button *on the tuner* to start the automatic tuning process. The radio will automatically switch to CW mode, transmit a low power (typically 10 watts) carrier, and start the tuning process. Once the automatic tuning is completed, the radio will return to its previous mode and power setting.

WARNING: Make sure the +13.8 volts connection on the radio's tuner port is capable of supplying the 1 amp of current required by the MFJ-993B.

The MFJ-5124A interface cable provides power and control signals between an Alinco radio and the MFJ automatic tuner. Supported Alinco radios are DX-70, DX-77, DX-701, DX-801, and any Alinco radio that supports the Alinco EDX-2 tuner. Press the radio's [TUNE] button to start the tuning process; for DX-70 press [FUNC] then [TUNE]. Refer to "Alinco Radio Interface" on page 32 for connections and operation.

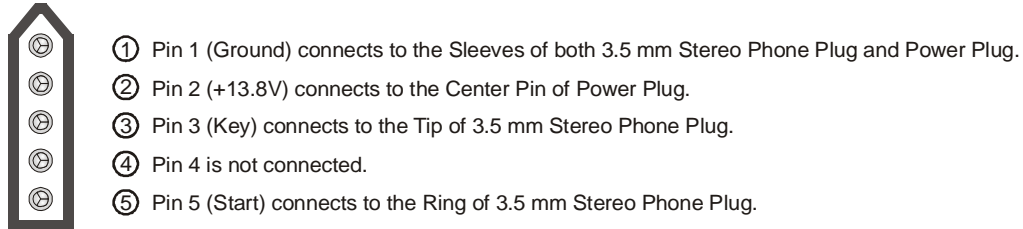

Figure 5. Alinco Interface Cable.

The MFJ-5124I interface cable provides power and control signals between an Icom radio and the MFJ automatic tuner. Supported Icom radios are IC-706, IC-707, IC-718, IC-728, IC-736, IC-738, IC-746, IC-756, IC-7000, and any Icom radio that supports the Icom AH-3 or AH-4 tuner. Push and hold the radio's [TUNER] button for two seconds to start the tuning process. Push [TUNER] quickly to bypass the tuner. Refer to "Icom Radio Interface" on page 33 for connections and operation.

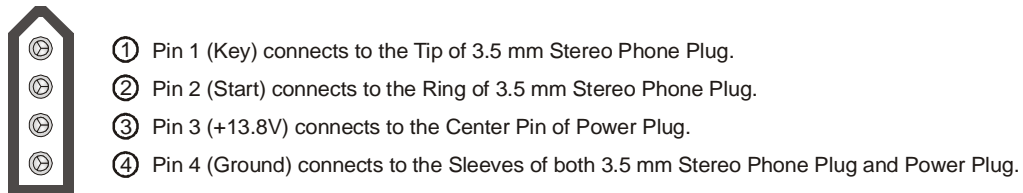

Figure 6. Icom Interface Cable.

The MFJ-5124K interface provides power and control signals between a Kenwood radio and the MFJ automatic tuner. Supported Kenwood radios are TS-50S, TS-450S, TS-480HX, TS-570S, TS-590S, TS-690S, TS-850S, TS-870S, TS-2000, and any Kenwood radio that supports the Kenwood AT-300 tuner. Push and hold the radio's [AT TUNE] button for one second to start the tuning process. Push the [AT TUNE] quickly to bypass the tuner or to cancel tuning in progress. Refer to "Kenwood Radio Interface" on page 34 for connections and operation.

Note: *The TS-480HX will automatically reduce its TX power to 100 watts maximum (25 watts AM) when the radio interface is used.*

Note: *For the TS-2000, use the ANT 1 and AT connectors on the radio to connect an external antenna tuner. If the external tuner is connected to the ANT 2 connector on the radio, the external tuner will not function with the radio interface.*

The MFJ-5124Y interface provides power and control signals between a Yaesu radio and the MFJ automatic tuner. Supported Yaesu radios are FT-100, FT-450, FT-857, FT-897, FT-950, and any Yaesu radio that supports the Yaesu FC-30 tuner. Push and hold the radio's (TUN) or (TUNE) key to start the tuning process. Refer to "Yaesu Radio Interface/MFJ-5124Y" on pages 35 to 38 for connections and operation.

The MFJ-5124Y2 interface provides control (but not power) between a Yaesu radio and the MFJ automatic tuner. Supported Yaesu radios are FT-847 and any Yaesu radio with a compatible CAT system. Push the [TUNE] button *on the tuner* for 0.5 to 2 seconds to start the tuning process. Refer to "Yaesu Radio Interface/MFJ-5124Y2" on page 39 for connections and operation.

The MFJ-5124Y3 interface provides control (but not power) between a Yaesu radio and the MFJ automatic tuner. Supported Yaesu radios are FT-1000MP, FT-1000MP MKV, FT-1000MP MKV Field, FTDX-9000, and any Yaesu radio compatible with the Yaesu FH-1 or FH-2 Remote Control. This cable plugs into the REMOTE jack on the rear panel of the Yaesu radios, and keys the Yaesu radios in the CW tune mode whenever the MFJ-993B's [TUNE] button is pushed. MFJ recommends that the Yaesu CW tune setting be set to 10 watts (Yaesu MP menu selection 4-3) during the tune process when an amplifier is not used. For best accuracy when an amplifier is used, MFJ recommends that the Yaesu CW tune setting be set to 50 watts for 100-watt transceivers and 75 watts for 200-watt MKV transceivers during the tune process. If a FH-1 or FH-2 keypad is also used, both the FH-1/FH-2 and the radio control cable may be plugged in parallel using a 3.5-mm headphone splitter (mono or stereo is fine). Refer to "Yaesu Radio Interface/MFJ-5124Y3" on pages 40 to 41 for connections and operation.

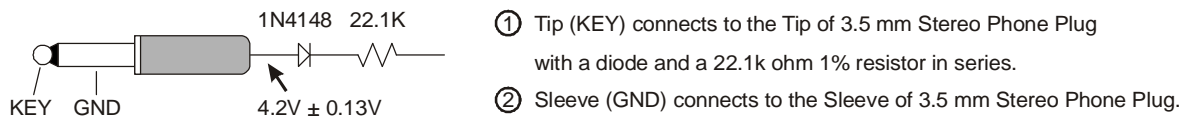

Figure 7. Yaesu Interface Cable (FT-1000MP/-9000 series).

The MFJ-5124Y4 interface provides control (but not power) between a Yaesu radio and the MFJ automatic tuner. Supported Yaesu radios are FT-2000 series, FTDX-5000 series, and any Yaesu radio with compatible TX REQ jack. This cable plugs into the TX REQ RCA jack on the rear panel of these Yaesu radios, and keys the Yaesu radios in the CW tune mode whenever the MFJ-993B's [TUNE] button is pushed. MFJ recommends that the Yaesu tune power setting be set to 20 watts (Yaesu menu 145 tGEN TUN PWR) during the tune process. Refer to "Yaesu Radio Interface/MFJ-5124Y4" on pages 41-42 for connections and operation.

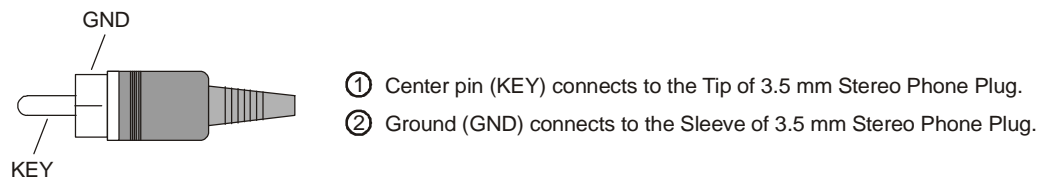

Figure 8. Yaesu Interface Cable (FT-2000/-5000 series).

- **Transmitter:** SO-239 connector for coax cable from transceiver or amplifier.
- **Ground:** Wing-nut terminal for RF ground wire connection.
- **Balanced Line:** Two binding posts for connecting balanced line antennas. To use balanced line antenna, install a jumper as shown to the WIRE binding post.
- **Wire:** Binding post for connecting single wire antennas. The WIRE binding post is internally connected to the ANTENNA 1 connector.

Note: When using the WIRE binding post, there should be no coax cable connected to the ANTENNA 1 connector.

- **Antenna 1:** SO-239 connector for coax cable from antenna. The ANTENNA 1 connector is internally connected to the WIRE binding post.

Note: When using the ANTENNA 1 connector, there should be no jumper and no wire attached to the WIRE binding post.

- **Antenna 2:** SO-239 connector for coax cable from antenna.

Installation

WARNING

- **Never operate the tuner with its cover removed. Contact with the components inside the tuner while transmitting will result in painful RF burns.**
- **Locate the tuner so that the rear terminals are *not accessible* during operation. The single wire and balanced line connection may have high voltage while transmitting.**
- **Disconnect all antennas from the tuner during lightning storms.**
- **Always tune with low power (2-20 watts) , and any in-line amplifier must be bypassed. Apply maximum power only after tuning up.**
- **Never exceed tuner specifications.**

1. Place the tuner in a convenient location at the operating position. When using a random wire or balanced line, the feed through insulators may have high RF voltages. These voltages can cause serious RF burns if the terminals are touched when transmitting. **Be sure to locate the tuner so these terminals cannot accidentally be contacted during operation.**
2. Connect the tuner to the transceiver or amplifier with 50-ohm coaxial cable (such as RG-8/U). See Figure 1 on page 4.
3. Connect the antenna(s) to the tuner as follows:
 - Coaxial feedlines (RG-8/U or better) to the SO-239 connectors labeled ANTENNA 1 and/or ANTENNA 2.

- Random wire to the WIRE binding post on the back of the tuner (and remove the jumper wire). Note the back panel warning: **Do not connect WIRE and ANTENNA 1 at same time!** When a single wire antenna is connected it “becomes” ANTENNA 1.

Note: Route all random wire antennas safely to prevent RF burn hazard.

- For a balanced feedline (open wire, twinlead, or twin-axial lines), place a jumper wire as indicated on the back panel and connect the balanced feedline to the BALANCED LINE binding posts. This antenna becomes ANTENNA 1. See “Antenna System Hints” on page 24.
4. A GROUND post is provided for an RF ground connection. See “Grounding Hints” on page 23.
 5. Connect a 12 to 15 VDC power source to the input jack labeled POWER.

SWR/Wattmeter

The backlit cross-needle meter measures forward power, reflected power, and SWR, and operates whenever the tuner is powered on. Forward power up to 300 watts is displayed on the left-hand FORWARD meter scale. Reflected power up to 60 watts is read on the right-hand REFLECTED meter scale. For low-power tuning, meter ranges of 30 watts forward and 6 watts reflected are available. Divide the readings on these scales by ten when in the low power meter range.

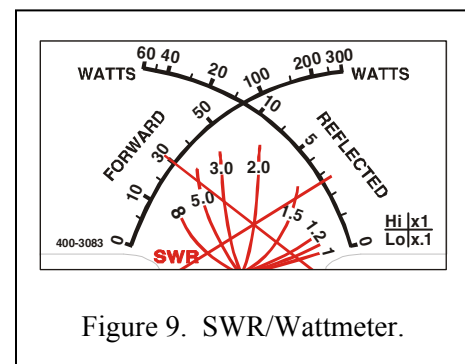

Figure 9. SWR/Wattmeter.

The meter can be set to low, high, or auto range. Auto range automatically sets the meter scales according to the input RF power to the tuner. Forward power greater than 30 watts or reflected power greater than six watts automatically sets the meter to the high power range. Forward power less than 25 watts and reflected power less than four watts automatically set the meter to the low power range. To cycle the meter range among low, high, and auto range, press the [TUNE] and [L-DN] buttons simultaneously. The forward needle will read “300” for high range, “30” for low range, and “100” for auto range until the buttons are released. When auto range is enabled, a two-dot vertical segment (low range) or a three-dot vertical segment (high range) appears in the lower right corner of the Range indicator on the main LCD screen. One beep indicates high range is selected; two beeps indicate low range; three beeps indicate auto range. Refer to Figures 13 and 14 for the on-screen Range indicator.

SWR is calculated from the forward and reflected power measurements as shown by the equation at the right. The SWR is read from the eight red SWR curves, ranging from 1.0 to infinity, by observing the point where the forward and reflected power needles cross on the red curved scales across the center of the meter. No cumbersome or time-consuming SWR sensitivity adjustments are required with this meter. Figure 9 shows an SWR of approximately 2.0.

$$SWR = \frac{1 + \sqrt{\frac{\text{reflected power}}{\text{forward power}}}}{1 - \sqrt{\frac{\text{reflected power}}{\text{forward power}}}}$$

The meter also indicates various operational states of the tuner. Refer to “Meter Codes and Audible Beeps” on page 21 for more details.

The MFJ-993B also includes an SWR bar meter and an audio SWR indicator, selectable by pressing [L-UP] and [L-DN] buttons simultaneously. It also has bar meters for forward and reflected power.

The Menus

Main Mode Menus

The main mode menus show various tuner settings and status. There are four main mode menus arranged in a “wrap-around” structure. When powered on, tuner operation starts with the main menu that was last used. Within each main menu, press the [MODE] button briefly to view the next main menu. Press and hold the [MODE] button for two seconds to enter the setup mode (see below). Various tuner indicators are shown on all four main menus: Antenna 1/2, IntelliTune™, Memory, Power Level, LC Limit, Meter Range, Auto/Semi, and StickyTune™. Refer to Figures 13 and 14 for details on the displayed information.

Note: *In sideband mode, the frequency readout on the tuner display jumps around to different frequencies while transmitting and stops on another frequency when un-keyed. This is normal and is a characteristic of sideband mode, because sideband signals jump up and down in frequency and power.*

Note: *In bypass mode, the decimal point in the SWR reading is replaced with a comma.*

Digital Wattmeter Menu

Shows the frequency, SWR, and forward and reflected power in watts.

Power Bar Meter Menu

Shows the frequency, SWR, forward power, and bar meters for forward and reflected power. The top bar meter is the forward power and the bottom bar meter is the reflected power. The numeric reading of forward power appears at the end of the bar meters. A power scale is printed just below the display on the front panel. Each power bar meter is consisted of 60 bar segments. When in the high power range, each vertical bar segment consists of three dots. Below 100 watts, each bar segment represents two watts; above 100 watts, each bar segment represents 20 watts. The forward bar meter has a “peak hold” feature. The peak meter hold function freezes the highest displayed bar segment of the forward power for about one second, so that you can more easily read the meter. This function can be turned ON and OFF in the Peak Hold setup mode.

For low-power tuning, meter range of 30 watts is available. When in the low power range, divide the readings on the printed power scale by ten and each vertical bar segment consists of two dots. Below 10 watts, each bar segment represents 0.2 watt; above 10 watts, each bar segment represents two watts. Refer to the “SWR/Wattmeter” section on page 12 for more details on power range.

The power meter can be set to auto range. Auto range automatically sets the meter scale according to the input RF power to the tuner. Forward power greater than 30 watts or reflected power greater than six watts automatically sets the meter to the high power range. Forward power less than 25 watts and reflected power less than four watts automatically set the meter to the low power range. When auto range is enabled, a two-dot vertical segment appears on the on-screen tuner indicator. Refer to Figures 13 and 14 for the on-screen Range indicator.

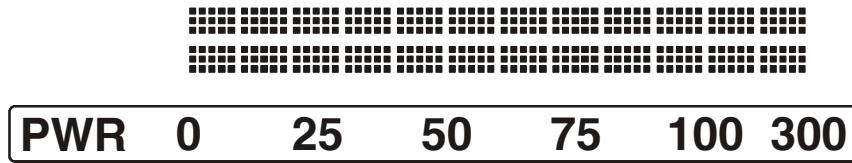

Figure 10. Power Bar Meter (High Range).

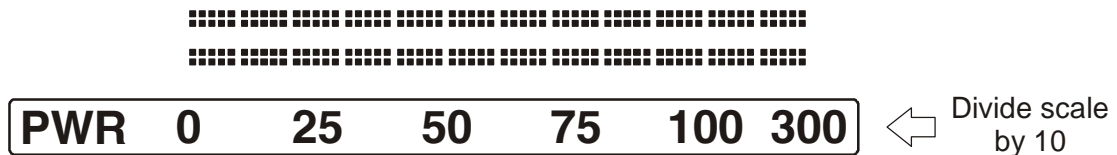

Figure 11. Power Bar Meter (Low Range).

SWR Bar Meter Menu

Shows the frequency, SWR, forward power, and SWR bar meter. A SWR scale is printed just below the display on the front panel. The 13-block (36-segment) SWR bar meter indicates SWR of 1.0, 1.1, 1.2, 1.3, 1.4, 1.5, 1.6-1.7, 1.8-2.0, 2.1-2.5, 2.6-3.0, 3.1-5.0, 5.1-15.0, and 15.1 to infinity. The numeric reading of forward power appears at the end of the bar meter. There is also an audio SWR indicator (see “SWR Beep Menu” section on page 20).



Figure 12. SWR Bar Meter.

L-Network Menu

Shows the configuration of the L-network matching circuit, SWR, and forward power. The antenna symbol, on the upper left corner, indicates the antenna side of the L-network. The capacitance value is displayed to the left when it is on the antenna side and to the right when on the transmitter side. Inductance value is shown in microhenries (μH) and capacitance value in picofarads (pF). The numeric reading of forward power appears at the lower right corner of the display. See “Manual Tuning” on page 21.

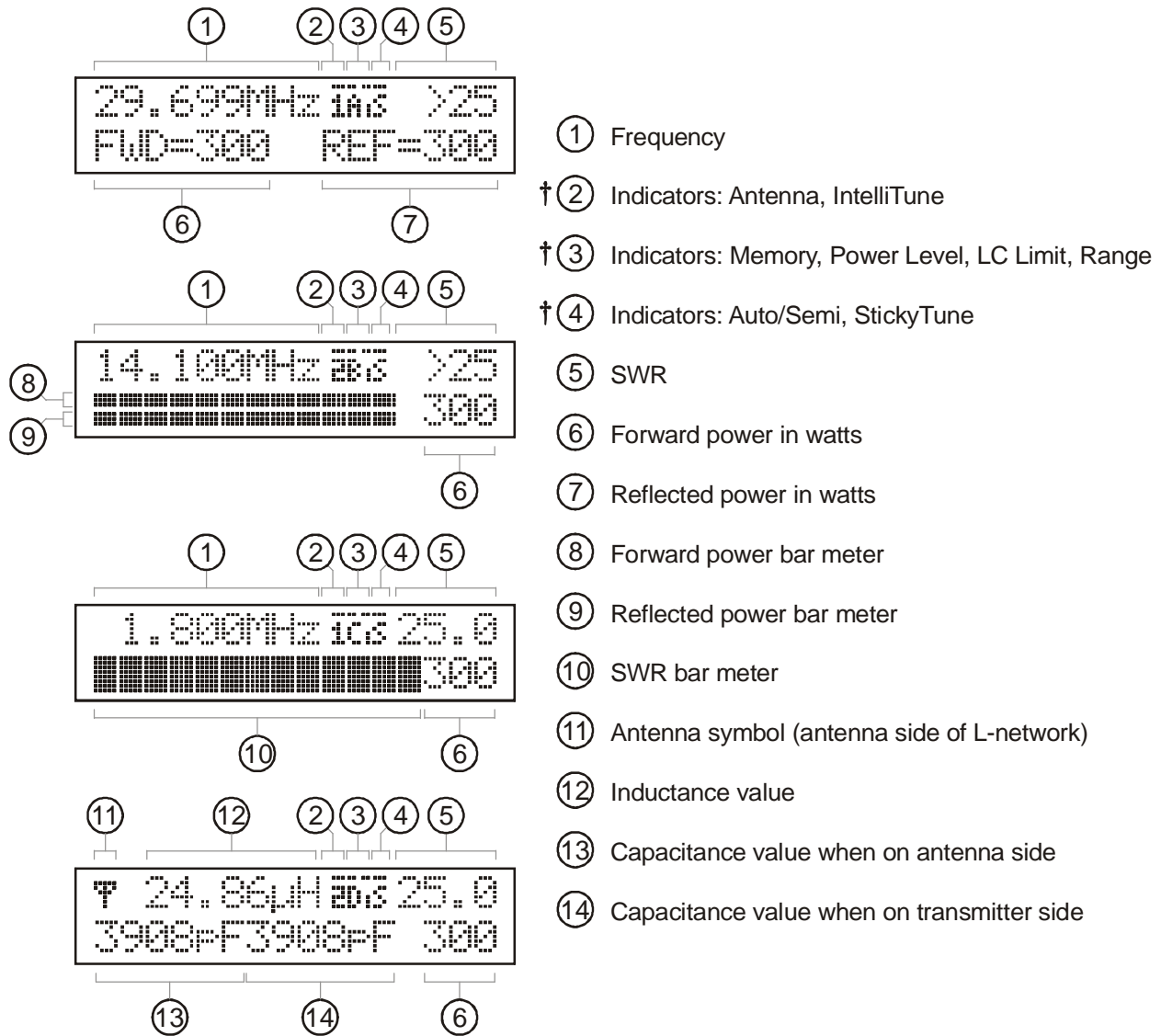

Figure 13. Main Mode Menus Display.

Tuner Indicators

Various tuner indicators are shown on the main menus to indicate tuner status. Refer to Figure 13 for locations of these indicators. The number enclosed within () is the item number of Figure 14.

- **Antenna:** A small “1” appears to indicate antenna 1 is selected (15); a small “2” appears to indicate antenna 2 is selected (16).
- **IntelliTune:** When *IntelliTune*[™] is ON, a bar appears on top of the Antenna indicator (17).
- **Memory:** A small “A”, “B”, “C” or “D” appears to indicator the selected memory bank when Memory is ON (18-21).
- **Power Level:** When 150-watt power level is selected, a bar appears on the upper-left corner of the Memory indicator (22).

- **LC Limit:** When LC Limit is OFF, a bar appears on the upper-right corner of the Memory indicator (23).
- **Meter Range:** When Auto Range is ON, a two-dot vertical bar segment appears on the lower right corner of the Memory indicator (24), another dot appears on top of this bar segment when the meter range is high, and no dot when the meter range is low (25).
- **Auto/Semi:** A small “S” appears to indicate semi-automatic mode; nothing appears to indicate automatic mode (26).
- **StickyTune:** When *StickyTune*[™] is ON, a bar appears on top of the Auto/Semi indicator (27).

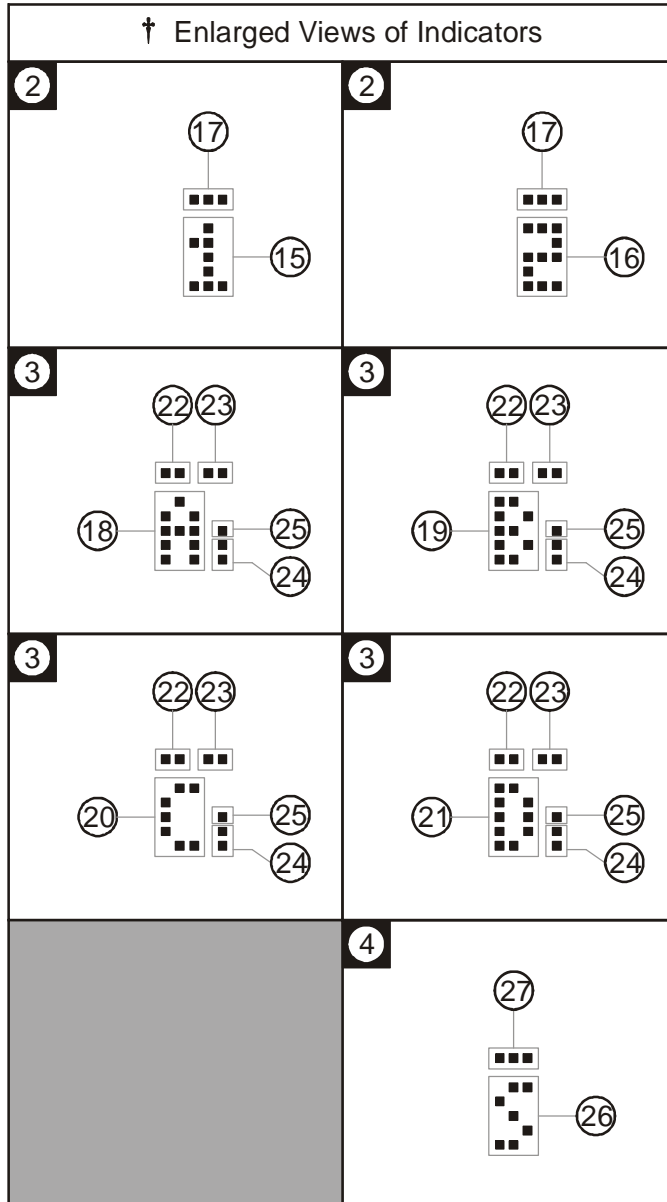

- ⑮ Appears when Antenna 1 is selected
- ⑯ Appears when Antenna 2 is selected
- ⑰ Appears when IntelliTune is ON
- ⑱ Appears when Memory Bank A is ON
- ⑲ Appears when Memory Bank B is ON
- ⑳ Appears when Memory Bank C is ON
- ㉑ Appears when Memory Bank D is ON
- ㉒ Appears when in 150-Watt Power Level
- ㉓ Appears when LC Limit is OFF
- ㉔ Appears when Auto Range is ON
- ㉕ Appears when in (Auto) High Range
- ㉖ Appears when in Semi-Auto mode
- ㉗ Appears when StickyTune is ON

Figure 14. Tuner Indicators.

Setup Mode Menus

The setup mode menus allow you to customize how the MFJ-993B tuner operates. There are 12 setup mode menus arranged in a “wrap-around” structure. To access these setup menus, press and hold the [MODE] button for two seconds. The setup menu that will display is the one that was last used. When finished, press the [MODE] button for two seconds to go back to the main mode for normal operation.

The tuner goes into protective bypass mode in the setup mode and restores the matching network after exiting the setup mode. If no button is pressed for more than eight seconds, the tuner automatically exits the setup mode, restores the matching network, and returns to the main mode.

To access the LC Limit setup menu from any setup menu, press and hold the [MODE] button and within two seconds press both [C-UP] and [L-UP] buttons. This difficulty is built-in so the LC Limit is not accidentally disabled. Notice the LC Limit is not saved into non-volatile memory and will revert back to default ON when power is turned off.

The following setup modes are stored separately for antennas 1 and 2: Power Level, Target SWR, Auto Tune SWR, Meter Range, Peak Hold, Memory, and *IntelliTune*TM.

Within each setup menu:

- Press the [MODE] button briefly to cycle through the setup menus; press and hold the [MODE] button for two seconds to exit the setup mode and go back to the main mode.
- Press the [C-UP] or [L-UP] button to increase or turn on the setting for the current setup menu.
- Press the [C-DN] or [L-DN] button to decrease or turn off the setting for the current setup menu.

Power Level Menu

Allows you to set the maximum power level the MFJ-993B can handle to 300 watts or 150 watts SSB/CW. Power level of 300 watts can match antennas with impedances of 6 to 1600 ohms; power level of 150 watts can match a wider impedance range of 6 to 3200 ohms. Default is 300 watts.

Shortcut: Press [TUNE], [C-UP] and [L-UP] buttons simultaneously to toggle the power level between 300 and 150 watts. Refer to Table 2 for meter code.

Target SWR Menu

Allows you to set the target SWR from 1.0 to 2.0. The tuning process will stop when a match with an SWR less than or equal to the target SWR is found. Setting the target SWR lower than 1.5 may result in longer tuning times. The target SWR is shown on the initial display when the tuner is powered on. Default is 1.5.

Shortcut: Press both [TUNE] and [C-UP] buttons simultaneously to toggle the target SWR between 1.5 and 2.0, which is indicated by the meter SWR scale. Refer to Table 2 for meter code.

Auto Tune SWR Menu

Allows you to set the SWR threshold in the range 0.5 to 1.5. In the automatic mode, the tuning process will automatically start when the SWR is above the target SWR by this amount of SWR threshold. For example, for target SWR of 1.5 and auto tune SWR of 0.5, the tuning process will start whenever the SWR rises above 2.0 ($1.5 + 0.5$) and there is at least two watts of RF power applied. Default is 0.5.

Shortcut: Press both [TUNE] and [L-UP] buttons simultaneously to cycle the auto tune SWR among 0.5, 1.0 and 1.5. Refer to Table 2 for meter code.

Note: *The AUTO button should always be IN (semi-automatic) unless a compatible radio interface cable is connected between the MFJ-993B and your transceiver. This will ensure that the MFJ-993B does not attempt tuning during high-power operation. This is particularly important when a HF amplifier is also being used.*

Note: *If an amplifier is in-line, it should always be bypassed prior to tuning.*

Meter Range Menu

Allows you to select the meter scale range. In the 30 watts (low) range, forward full scale is 30 watts and the reflected full scale is 6 watts (divide the meter reading by 10). In the 300 watts (high) range, the forward full scale is 300 watts and the reflected full scale is 60 watts. Auto range automatically sets the meter scales according to the input RF power to the tuner. Forward power greater than 30 watts or reflected power greater than six watts automatically sets the meter to the high power range. Forward power less than 25 watts and reflected power less than four watts automatically set the meter to the low power range. Refer to Figures 13 and 14 for the on-screen Meter Range indicators. Default is the 300-watt range.

Shortcut: Press both [TUNE] and [L-DN] buttons simultaneously to cycle the meter range among 30 watts, 300 watts and auto range. Refer to Table 2 for meter code.

Peak Hold Menu

When the peak hold function is ON, the highest activated segment of the forward bar meter remains visible for about one second, so that you can more easily read it. When OFF, the meter functions normally. Default is ON.

Memory Menu

Turns the antenna memory on and off. The “memory resolution” is the width of frequency spectrum that the tuner recognizes as being the same as a tuned frequency already in memory. The memory resolution is approximately 0.1 percent of the lower frequency of each amateur band. For example, the memory resolution on the 40-meter band (7000 to 7300 kHz) is 7 kHz; if the tuner has memorized a setting for 7050 kHz, it will automatically call up this setting for any frequency from 7047 to 7053 kHz. Memory resolution is smaller at lower frequency to accommodate the higher antenna Q and larger at higher frequency where the antenna Q is lower. The memory resolutions for the HF amateur bands are:

Meter	Frequency Range (kHz)	Memory Resolution (kHz)
160	1800 – 2000	2
75/80	3500 – 4000	4
60	5330.5, 5346.5, 5366.5, 5371.5 and 5403.5	5 memory locations
40	7000 – 7300	7
30	10100 – 10150	10
20	14000 – 14350	14
17	18068 – 18168	18
15	21000 – 21450	21
12	24890 – 24990	25
10	28000 – 29700	28

Table 1. Memory Resolution.

The memory resolution for non-amateur frequency bands between 160 and 10 meters is approximately 0.2 percent of the lower frequency of that band. There are over 2500 memory locations for each memory bank, and each antenna has four memory banks (A-D). Tuner settings are stored in memory separately for Antenna 1 and Antenna 2 (settings for balanced line or single-wire antenna are stored as Antenna 1). This provides memory for up to eight different antennas. Refer to Figures 13 and 14 for the on-screen Memory indicator. Defaults are memory banks 1A and 2A ON.

Shortcut: Press both [TUNE] and [C-DN] buttons simultaneously to turn on the antenna memory and to cycle the memory banks A, B, C and D. Refer to Table 2 for meter code.

To clear the memory for an antenna (all four banks), select the antenna with the [ANT] button and turn off the power to the tuner. Then press and hold both [TUNE] and [C-DN] buttons while turning on the power. A `DELETE ANTENNA` message will appear.

“Total Reset” erases both antenna memories and returns all tuner settings to their factory default states. To achieve this, turn power off, press and hold [TUNE], [L-DN] and [C-DN] buttons while turning on the power. A `TOTAL RESET` message will appear.

Note: Pressing [TUNE], [C-DN] and [L-DN] buttons simultaneously overwrites the tuner memory with the current tuner setting; settings with SWR greater than 3.0 will not be stored.

IntelliTune Menu

Turns the *IntelliTune*TM tuning algorithm on and off. When the tuner cannot find an appropriate setting in its memory, it begins its calculation function. It measures the complex impedance of the antenna (load) at the transmitting frequency, then it calculates the L/C components needed for a match. Then it fine-tunes the component values. If for any reason the tuner cannot calculate the load impedance, it proceeds to yet another method of calculation. If for any reason, this function can be turned off. Refer to Figures 13 and 14 for the on-screen *IntelliTune*TM indicator. Default is ON.

SWR Beep Menu

Turns the audio SWR meter on and off. The audio meter is a series of beeps where one beep indicates SWR of 1.5 or less, two beeps indicate SWR of 1.6 to 2.0, three beeps indicate SWR of 2.1 to 2.5, and four beeps indicate SWR of 2.6 to 3.0. For SWR above 3.0, “SWR” (di-di-dit di-dah-dah di-dah-dit) will be sent on CW. This functions independent of the acknowledgement beep setting. Default is OFF.

Shortcut: Press both [L-UP] and [L-DN] buttons simultaneously to toggle SWR Beep on and off.

Beep Menu

Acknowledgement beep sounds each time a parameter is changed to acknowledge it. This also controls the CW notification of “QRO”, “QRP” and “QRT”. This function can be turned OFF for silent operation, and this is independent of the SWR beep setting. Default is ON.

Refresh Menu

When the refresh function is ON, the display is updated while tuning is in progress. Default is OFF.

Note: Refresh slows tuning progress as it takes time to update the display.

Power-On Reset (POR) Sticky Tune Menu

Determines the state of *StickyTune*[™] when power is cycled. Default is OFF. If ON, then *StickyTune*[™] will be active for the first tune only. Then it will turn off. *StickyTune*[™] can be enabled by cycling power with POR Sticky Tune set to ON or by pressing [TUNE] for more than two seconds.

LC Limit Menu

The upper limits of inductance (L) and capacitance (C) are factory-limited according to frequency and maximum power rating; i.e., higher frequencies need less inductance and less capacitance when the L-network is properly tuned. Pressing [C-UP] and/or [L-UP] allows capacitance and inductance to be increased only to these limits. When a selected capacitance or inductance is higher than its allowed limit, and the frequency is changed, that selection is automatically reduced to the value of its limit. These limits are used to prevent matching of extreme load impedance outside the tuner’s specification, which may result in excess voltage and/or current across the tuner’s components. This setting is not stored in non-volatile memory and reverts back to the default when the tuner power is turned off. Refer to Figures 13 and 14 for the on-screen LC Limit indicator. Default is ON.

Note: If this feature is turned OFF, it will be re-set to ON whenever power is cycled.

WARNING: LC Limit is a safety precaution; the tuner is in danger of being damaged if this function is turned off.

Operation

Manual Tuning

Manual tuning may be used to “touch up” the tuner’s settings. For example, if the target SWR is set at the default of 1.5, the tuner will stop when a match of 1.5 is found. In all cases, manual tuning gives the user control of the tuner if desired, and the L-Network menu provides a picture of the matching network configuration. Manual tuning should always be done at low power, and is accomplished by using the [C-UP], [C-DN], [L-UP], and [L-DN] buttons. Since it is not known if more or less capacitance or inductance is needed, manual tuning must be by trial-and-error. As an example, to manually tune capacitance, press [C-UP] one time, and the reflected power will indicate if [C-UP] was the right “direction.” If it was, press [C-UP] again and observe reflected power. If not, press [C-DN] twice (once to return to the original setting of C, and once for one click past it).

Manual tuning of inductance is similarly accomplished, using [L-UP] and [L-DN]. Since the capacitance and inductance are interdependent, some back-and-forth between the two may be needed, just as in a conventional tuner with knobs.

Pressing [C-UP] and [C-DN] simultaneously moves the capacitance back and forth from one side of the inductance to the other. The L-Network menu displays the capacitance on the left to indicate that the capacitance is on the antenna side (corresponding with the rear panel configuration of connectors); the capacitance value moves to the right side of the display when the capacitance is on the transmitter side of the inductance. A general rule of thumb is that loads with impedance higher than 50 ohms call for the capacitance on the antenna side; loads with impedance lower than 50 ohms call for the capacitance on the transmitter side.

Pressing [C-DN] and [L-DN] simultaneously or pressing [TUNE] quickly places the tuner in bypass mode; i.e. zero inductance and zero capacitance. RF from the transmitter goes directly to the antenna with no matching. The reflected needle bounces to 20-watt mark to indicate the bypass mode. Also, the decimal point in the SWR reading is replaced with a comma.

Pressing [TUNE], [C-DN] and [L-DN] simultaneously (must be pressed within 80ms of each other) overwrites the tuner memory with the current tuner setting. Settings with SWR greater than 3.0 will not be stored. Both forward and reflected needles go to full scale to indicate memory overwrite.

Meter Codes and Audible Beeps

In addition to displaying power and SWR, the meter also indicates tuner status. The meter needles bounce, or rise to one point and stay, to provide information. In this mode the meters do *not* indicate power levels. For example, when you press [C-DN] and [L-DN] simultaneously to place the tuner in bypass mode, the reflected needle bounces to the 20 watts mark until you release the buttons. The following tables show the meter needle stationary and bounce codes.

Meter Needle Stationary Codes

(Meter needles stay at the indicated mark until buttons are released.)

Forward	30 Watts Mark	100 Watts Mark	300 Watts Mark
[TUNE] + [L-DN]	30 Watts Meter Range [1 beep]	Auto Range [3 beeps]	300 Watts Meter Range [2 beeps]
[TUNE] + [C-UP] + [L-UP]	Not Used	150 Watts Mark 150 Watts Power Level [1 beep]	300 Watts Mark 300 Watts Power Level [2 beeps]
[TUNE] + [C-DN]	10 Watts Mark Memory Bank A [1 beep]	20 Watts Mark Memory Bank B [2 beeps]	30 Watts Mark Memory Bank C [3 beeps]
			40 Watts Mark Memory Bank D [4 beeps]
Reflected	5 Watts Mark	20 Watts Mark	60 Watts Mark
[TUNE] + [L-UP]	Auto Tune SWR +0.5 [1 beep]	Auto Tune SWR +1.0 [2 beeps]	Auto Tune SWR +1.5 [3 beeps]
[TUNE] 2 seconds	Sticky Tune Off [2 beeps]	Not Used	Sticky Tune On [1 beep]
Both Needles	Zero Scale	Mid Scale	Full Scale
[C-UP] (YES) [L-UP] (NO)	No CANCEL [2 beeps]	Delete Confirmation? DELETE ANTENNA TOTAL RESET	Yes DELETED or RESET [1 beep]
[TUNE] + [C-DN] + [L-DN]	Not Used	Not Used	Memory Overwrite [1 beep]
[TUNE] + [C-UP]	Needles Intersect at SWR 1.5 Target SWR 1.5 [1 beep]		Needles Intersect at SWR 2.0 Target SWR 2.0 [2 beeps]

Table 2. Meter Needle Stationary Codes.

If not enough power is applied for tuning (less than 2 watts), the display will flash INCREASE POWER three times and “QRO” (dah-dah-di-dah di-dah-dit dah-dah-dah) will be sent on CW. Increasing the input power above two watts ends this message.

When input power is too high, the tuner enters a self-protection mode. The tuner will not allow any of its relays to change. This feature is to prevent damage to your tuner.

If too much power is applied when tuning, the tuner will cease the tuning routine, flash DECREASE POWER three times and send “QRP” (dah-dah-di-dah di-dah-dit di-dah-dah-dit) on CW. This occurs when the forward power exceeds 75 watts and the SWR is greater than 3.0, or when the forward power exceeds 125 watts regardless of the SWR.

If more than 300 watts (or more than 150 watts when 150 watts power level is selected) is applied to the tuner, the tuner will go into bypass mode, flash OVERLOAD three times and send “QRT” (dah-dah-di-dah di-dah-dit dah) on CW.

If the tuning process is activated under these conditions, the tuner will not start the tuning. It will indicate the appropriate bounce code on the meter and display a warning message on the LCD.

Meter Needle Bounce Codes

(Meter needles bounce to the indicated mark until buttons are released.)

Forward	30 Watts Mark	100 Watts Mark	300 Watts Mark
	Capacitor Switches To Transmitter Side [2 beeps]	Insufficient Power to Tune (Forward < 2 Watts) INCREASE POWER [QRO]	Power Too High to Tune (Forward > 125 Watts, or Forward > 75 Watts and SWR > 3) DECREASE POWER [QRP]
Reflected	5 Watts Mark	20 Watts Mark	60 Watts Mark
	Capacitor Switches To Antenna Side [1 beep]	Bypass Mode (L = 0 and C = 0) [1 beep]	L or C at Its Limit During Manual Adjustment [1 beep at lower limit] [2 beeps at upper limit]
Both Needles	30/5 Marks	100/20 Marks	300/60 Marks
	Not Used	Not Used	Power Overload (Forward > 300 or 150 Watts) OVERLOAD [QRT]

Table 3. Meter Needle Bounce Codes.

Transceiver Foldback

Modern transceivers with solid-state finals usually have a foldback circuit to protect the final transistors from damage due to high SWR. A foldback circuit detects the SWR during transmit and reduces the output power as the SWR rises above a preset threshold, usually 2:1. The higher the SWR, the lower the power is set to prevent damage.

However, even if your transceiver has a foldback circuit, you should manually set the power level to 20 watts or less for tuning. Even with foldback, the tuning process can be hard on your transceiver’s finals. When an amplifier is used, the amplifier must be bypassed during tuning.

Note: MFJ recommends that a transceiver-specific interface cable be used between the MFJ-993B and your transceiver to ensure that tuning only occurs at low power.

Grounding Hints

To minimize RFI, single wire feedlines (such as used with Windom or longwire antennas) should be kept away from other wiring. Radiation will be minimized if the single wire feeder runs parallel and reasonably close to the wire that connects the tuner to the outdoor ground. The antenna feed wire should be adequately insulated to prevent arcing or accidental contact.

CAUTION

For operator safety, a good outside earth ground or water pipe ground should always be installed and connected to the case of the MFJ-993B. Make certain the safety ground also connects to the transmitter and other station accessories. A wing-nut post marked GROUND is provided for ground connections.

For safety, always use good DC and RF grounds. It is particularly important to have a good RF ground when using a single wire feeder since the tuner needs something to "push" against in order to force current into the single wire feedline. If a good RF ground is not available, RF will usually find its way back into the power line (RFI), transmitter audio circuits (RF feedback), or the operator (RF burns).

Metal water pipes and ground rods provide good DC and AC safety grounds, but they are almost useless for dependable RF grounding.

RF grounds work much better when "spread out" over a large area, especially when they employ multiple connections directly to the equipment ground point. Metal water pipes, heating ducts, and fences may work (especially if they are connected together with multiple wires), but the best RF grounds are radial systems or multi-wire counterpoises. Radials and counterpoises provide large, low resistance surfaces for RF energy.

RF and lightning travel on the surface of conductors. Braided or woven conductors have high surface resistance to lightning and RF. Ground leads for RF and lightning should have wide smooth surfaces. Avoid the use of woven or braided conductors in RF and lightning grounds unless the lead needs to be flexible.

Antenna System Hints

Coaxial Cable Selection

The proper selection of coax cable will minimize antenna system losses, especially in the presence of high SWR. And the coax cable selection is particularly important in high power amateur installations. RG-58/U or RG-8X is fine for interconnecting the transceiver output and amplifier input. However, these cable types are unacceptable at the amplifier output and tuner output due to power handling capability and loss – especially loss in the presence of high SWR. As an example, RG-58/U has a maximum power handling capability of 570 watts and loss of 2.4 dB/100 feet at 28 MHz under matched conditions, while the maximum power for RG-8X is just 360 watts with a loss of 1.9 dB/100 feet at 28 MHz under matched conditions. When the SWR rises, the power handling capability decreases by $1/\sqrt{\text{SWR}}$ and loss also increases. Therefore MFJ recommends that RG-8/U, RG-213, LMR-400 or other high quality coax cables be used between the MFJ-993B output and the antenna. Refer to The Radio Amateurs Handbook and The ARRL Antenna Book for more information.

Location

For the best performance, an end-fed longwire wire antenna should be at least one quarter-wavelength long at the operating frequency. Horizontal dipole antennas should be at least a half-wavelength long and located as high and clear as possible. While good RF grounds help the signal in almost any transmitting installation, it is extremely important to have good RF grounds with long wire or other Marconi-style antennas.

Matching Problems

Most matching problems occur when the antenna system presents an extremely high impedance to the tuner. When the antenna impedance is much lower than the feedline impedance, an *odd quarter-wavelength* feedline converts the low antenna impedance to a very high impedance at the tuner. A similar problem occurs if the antenna has an extremely high impedance and the transmission line is a multiple of a half-wavelength. The half-wavelength line *repeats* the very high antenna impedance at the tuner. Incorrect feedline and antenna lengths can make an otherwise perfect antenna system very difficult or impossible to tune.

One example where this problem occurs is on 80 meters when an odd quarter-wave (60 to 70 feet) open wire line is used to feed a half-wave (100 to 140 feet) dipole. The odd quarter-wave line transforms the dipole's low impedance to over three thousand ohms at the tuner. This is because the mismatched feedline is an *odd multiple* of 1/4 wavelength long. The line *inverts* (or teeter-totters) the antenna impedance.

A problem also occurs on 40 meters with this same antenna example. The feedline is now a multiple of a half-wave (60 to 70 feet) and connects to a full-wave high impedance antenna (100 to 140 feet). The half-wave line repeats the high antenna impedance at the tuner. The antenna system looks like several thousand ohms at the tuner on 40 meters.

This places enormous strain on the balun and the insulation in the tuner, since voltages can reach several thousand volts. This can cause component arcing and heating.

The following suggestions will reduce the difficulty in matching an antenna with a tuner:

- Never center feed a half-wave multi-band antenna with a high impedance feedline that is close to an odd multiple of a quarter-wave long.
- Never center feed a full-wave antenna with a feedline close to a multiple of a half-wave long.
- If this tuner will not "tune" a multi-band antenna, add or subtract 1/8 wave of feedline (for the band that won't tune) and try again.
- Never try to load a G5RV or center fed dipole on a band below the half-wave design frequency. If you want to operate an 80-meter antenna on 160 meters, feed either or both conductors as a longwire against the station ground.

To avoid problems matching or feeding any dipole antenna with high impedance open wire lines, keep the lines around these lengths. [The *worst possible* line lengths are shown in brackets]:

160 meters dipole:	35-60, 170-195 or 210-235 feet	[Avoid 130, 260 ft]
80 meters dipole:	34-40, 90-102 or 160-172 feet	[Avoid 66, 135, 190 ft]
40 meters dipole:	42-52, 73-83, 112-123 or 145-155 feet	[Avoid 32, 64, 96, 128 ft]

Some slight trimming or adding of feedline may be necessary to accommodate the higher bands.

WARNING

To avoid problems, a dipole antenna should be a full half-wave on the lowest band. On 160 meters, an 80 or 40 meters antenna fed the normal way will be extremely reactive, with only a few ohms of feedpoint resistance. Trying to load an 80 meters half-wave dipole (or shorter) antenna on 160 meters can be a disaster for both your signal and the tuner. The best way to operate 160 meters with an 80 or 40 meters antenna is to load either or both feedline wires (in parallel) as a longwire. The antenna will act like a "T" antenna worked against station ground.

Appendices

POWER-ON OPERATIONS			
(Press and hold buttons while turning on the power.)			
Press and hold	C-UP	+	POWER to get the firmware version number.
Press and hold	L-UP	+	POWER to start the self test.
Press and hold	C-DN	+	POWER to test the relays.
Press and hold	L-DN	+	POWER to test the power-down circuitry.
Press and hold	C-UP + C-DN	+	POWER to calibrate the wattmeter.
Press and hold	L-UP + L-DN	+	POWER to output audio for volume adjustment.
Press and hold	C-UP + L-UP	+	POWER to calibrate the SWR bridge.
Press and hold	C-DN + L-DN	+	POWER to calibrate the frequency counter.
Press and hold	TUNE + C-DN + ANT	+	POWER to delete the selected antenna memory.
Press and hold	TUNE + L-DN	+	POWER to reset factory defaults.
Press and hold	TUNE + C-DN + L-DN	+	POWER to perform total reset.

Figure 15. Power-On Operations.

Important: *The radio interface cable must be disconnected from the tuner, if the radio power is off, before performing any of the following power-on operations.*

Resetting the Tuner

Each time the tuner is powered off, the microprocessor saves all memories and configurations to non-volatile memory. When the power is off, the tuner is bypassed (straight through from TRANSMITTER to ANTENNA 1 and WIRE). When power is turned on, the tuner powers-up bypassed, but will revert to the last stored matching values or begin tuning on application of RF power when the TUNE button is pressed – or if Automatic or Sticky-Tune is enabled. If the tuner is not working properly, even on initial power on, try resetting to the factory defaults.

Factory Defaults

The unit is shipped with the following default settings for both antennas:

- Main Menu Digital Wattmeter
- Setup Menu Target SWR
- Inductance 0 μH
- Capacitance 0 pF on transmitter side
- Power Level 300 watts †
- Target SWR 1.5 †
- Auto Tune SWR 0.5 above target SWR †

- | | | |
|-------------------|------------------------|---|
| • Meter Range | 300 watts (high range) | † |
| • Peak Hold | ON | † |
| • Memory | Banks 1A and 2A on | † |
| • IntelliTune | On | † |
| • SWR Beep | Off | |
| • Beep | On | |
| • Refresh | Off | |
| • POR Sticky Tune | On | |

† These settings are stored separately for antennas 1 and 2.

Note: Resetting to factory defaults does not erase the antenna memories.

To reset the tuner to these defaults:

1. Turn off the power to the tuner.
2. Press and hold *both* the [TUNE] and [L-DN] buttons while turning the power on.
3. Release the buttons when DEFAULTS RESET appears on the display and both meter needles read full scale.
4. Resume normal operation.

WARNING: If the MFJ-993B is behaving weirdly or acting erratic, try resetting the tuner to factory defaults.

Delete Antenna Memory

To delete an antenna memory, select Antenna 1 or Antenna 2 with the [ANT] button that you want to delete. Turn off power to the tuner, and then press and hold *both* the [TUNE] and [C-DN] buttons while turning the power back on. A confirmation message DELETE ANTENNA will display. Press the YES [C-UP] button to delete the antenna memory (DELETED will display and both meter needles go to full scale), or press the NO [L-UP] button to cancel (CANCEL will display and both meter needles go to zero scale). Release the button to resume normal operation. Remember that the selected antenna memory will be lost!

Total Reset

To erase *both* antenna memories and reset to factory defaults, press and hold down the [TUNE], [C-DN] and [L-DN] buttons while turning the power on. A confirmation message TOTAL RESET will display. Press the YES [C-UP] button to delete both antenna memories and reset factory defaults (RESET will display and both meter needles go to full scale), or press the NO [L-UP] button to cancel (CANCEL will display and both meter needles go to zero scale). Release the button to resume normal operation. Remember that both antenna memories will be lost and tuner settings will return to default!

Self Test

A self-test routine will check the functions of the MFJ-993B. This routine checks the display, the meter, the front-panel buttons, the internal memory and the audio circuitry. During the self-test, you may stop the test by turning off the unit; however, this should NOT be done during the memory test or the memory could be corrupted. The self-test can be completed in approximately 30 seconds.

This test can also be used to test the optional MFJ-993RC Remote Control. Make sure to press both [ANT] and [AUTO] buttons on the MFJ-993B tuner to the in position before starting the self-test, and press the buttons on the MFJ-993RC instead of the front-panel buttons when prompted.

Note: Performing the self-test will reset the unit to its factory default settings.

Here is the self-test procedure:

1. Turn off the power to the tuner, and press all buttons to the *out* position.
2. Unplug the radio interface cable, if one is connected, from the tuner.
3. If testing the MFJ-993RC Remote Control, connect it to the Remote Port and make sure both [ANT] and [AUTO] buttons *on the tuner* are locked in.
4. Set volume to a comfortable listening level.
5. Press and hold *only* the [L-UP] button while turning the power on.
6. The test begins by displaying a copyright message and firmware version number, such as COPYRIGHT (c) 2003-20YY MFJ ENTERPRISES, INC. VERSION YYWW. This is the test of the display. At the same time, the forward needle of the meter also goes up slowly to full scale and then drops to zero, followed by the reflected needle going up slowly to full scale and then drops to zero. This tests the meter. Release the [L-UP] button before the message completes. To skip this copyright message, press [C-DN] button.
7. You will be prompted to press each of the front-panel buttons. The forward needle should bounce once for each press, and the reflected needle should move up a division for each press.
8. The unit then tests its non-volatile memory. Notice this step will reset the unit to its factory default settings.
9. If the unit is okay, a repetitive message PASS will be displayed and sent as Morse code (di-dah-dah-dit di-dah di-di-dit di-di-dit), and both meter needles will go to full scale. If there is a problem, a failure message will be displayed and sent; also, the forward needle will bounce and the reflected needle mark indicates the failure.
10. Once you have confirmed that the audio is okay, turn the unit off.

Failure Message	Reflected Needle (watts)	Indicates
ANT FAIL	1	[ANT] button is shorted or improperly connected.
MODE FAIL	2	[MODE] button is shorted or improperly connected.
C-UP FAIL	3	[C-UP] button is shorted or improperly connected.
C-DN FAIL	4	[C-DN] button is shorted or improperly connected.
L-UP FAIL	5	[L-UP] button is shorted or improperly connected.
L-DN FAIL	7.5	[L-DN] button is shorted or improperly connected.
AUTO FAIL	10	[AUTO] button is shorted or improperly connected.
TUNE FAIL	15	[TUNE] button is shorted or improperly connected. Radio interface cable is connected but radio power is off.
MEMORY FAIL	20	Non-volatile memory circuitry is improperly connected.
WAKEUP FAIL	30	Microprocessor wakeup circuitry problem.
PD FAIL	40	Power down circuitry problem.

Table 4. Failure Messages.

Power-Down Circuit Test

When the 12 VDC power to the tuner is turned off, the tuner saves all settings to non-volatile memory. The Power-Down Circuit Test checks the power down detection circuitry. It is recommended that this test be done immediately after the regular self-test described above.

Note: *The tuner must be reset to factory defaults before performing this test.*

Here is the test procedure:

1. Make sure power to the tuner is off.
2. If the tuner has been reset to factory defaults, skip to step 6; otherwise continue with step 3.
3. Press and hold *both* the [TUNE] and [L-DN] buttons while turning the power on.
4. Release both buttons when `DEFAULTS RESET` appears on the display.
5. Turn the power off.
6. Press and hold *only* the [L-DN] button while turning the power on.
7. If the power down detection circuitry is okay, a repetitive message `PASS` will be displayed and sent as Morse code (di-dah-dah-dit di-dah di-di-dit di-di-dit). If there is a problem, message `PD FAIL` will be displayed and sent as Morse code repetitively.
8. Turn the power off.

Relay Test

WARNING: Turn off the transmitter power or disconnect the transmitter before performing this test; otherwise, damage to the tuner can result.

To test the relays and their control circuitry, press and hold the [C-DN] button while turning the power on. The message `RELAY TEST` will appear. Four numbers representing the relays will be shown in the center of the display. The [C-UP], [L-UP], [C-DN] and [L-DN] buttons, corresponding to the position of the relay numbers on the display, are used to toggle each relay on and off. Press button to engage the relay and release it to disengage the relay. Listen for relay clicks. Press the [TUNE] button to proceed to the next group of four relays. There are 19 relays in the tuner. Repeat the above procedure to test all the relays. Normal operation is resumed after this test.

Firmware Version Number via Meter

Make sure the meter is calibrated. The firmware version number is shown in the copyright message of the self-test. To obtain a decimal firmware version number via the meter, press and hold the [C-UP] button while turning the power on. The version number X.YY is represented by the meter forward needle for X (forward reading ÷ 10) and the reflected needle for YY (reflected reading). For example, forward needle on 10-watt mark and reflected needle on 20-watt mark represent firmware version number 1.20. Release button to resume normal operation.

Setting the Speaker Volume

To set the speaker volume, press and hold *both* the [L-UP] and [L-DN] buttons while turning the power on. The message `SET VOLUME` will display and send as Morse code repetitively. Insert a small flat blade screwdriver into the VOL hole on the front panel to adjust the volume level. Turn clockwise to increase volume level. Turn the power off.

Wattmeter Calibration

To calibrate the meter needles, you will need a Phillips screwdriver and a tuning tool or small flat blade screwdriver.

WARNING: Never operate the MFJ-993B with its cover removed; dangerous voltages and currents can be present during operation. Never exceed tuner specifications.

Note: *The trimmers involved in this calibration are located on the circuit board behind the front panel; do not confuse these with the SWR bridge trimmers.*

1. Turn off the power to the tuner and the transmitter.
2. Remove the cover from the tuner (12 screws) with a Phillips screwdriver.
3. Press and hold *both* the [C-UP] and [C-DN] buttons while turning the power on.
4. A message `CAL FWD METER TO 100 WATTS` will display and both meter needles will bounce. Use a small flat blade screwdriver and adjust the FWD trimpot R75, located behind the display, to set the forward needle to the 100-watt mark.
5. Press the [TUNE] button to calibrate the reflected needle.
6. A message `CAL REF METER TO 20 WATTS` will display. Adjust the REF trimpot R76, located behind the display, to set the reflected needle to the 20-watt mark.
7. Press the [TUNE] button to end calibration.
8. Turn off the tuner power and secure the cover back onto the tuner.

SWR Bridge Calibration

To calibrate the SWR Bridge, you will need a transmitter capable of 100 watts output, a precise calibrated wattmeter, a 50-ohm dummy load, three 50-ohm SO-239 coax cables, a Phillips screwdriver, and a tuning tool or small flat blade screwdriver.

WARNING: Do not touch anything inside the tuner during operation! Serious, painful RF burns can result.

WARNING: Never operate the MFJ-993B with its cover removed; dangerous voltages and currents can be present during operation. Never exceed tuner specifications.

Note: *The trimmers involved in this calibration are located on the main circuit board in front of the TRANSMITTER connector; do not confuse these with the SWR/wattmeter trimmers.*

1. Turn off the power to the tuner and the transmitter.

2. Remove the cover from the tuner (12 screws) with a Phillips screwdriver.
3. Connect the 50-ohm dummy load to the ANTENNA 1 connector; connect the wattmeter between the transmitter and the TRANSMITTER connector on the tuner.
4. Turn on the power to the transmitter. Using a frequency in the middle of the HF band, such as 7.253 MHz, for calibration is recommended.
5. Press and hold *both* the [C-UP] and [L-UP] buttons while turning the tuner power on.
6. A message `CAL CAP AND FWD` will display and both meter needles will bounce. Key the transmitter to output 100 watts and adjust trimmer capacitor C91 for minimum reflected power. Notice the reflected meter movement is exaggerated for easier calibration.
7. Key the transmitter to 100 watts output and adjust the FWD trimpot R72 until the display shows forward power of `FWD=100` watts. The forward meter also should indicate 100 watts.
8. Press the [TUNE] button. A message `REVERSE, CAL REF` displays and the reflected meter goes to full scale.
9. Turn off the transmitter and reverse the ANTENNA 1 and TRANSMITTER connections; that is, connect the 50-ohm dummy load to the TRANSMITTER connector and connect the transmitter/wattmeter to the ANTENNA 1 connector.
10. Turn on the transmitter's power.
11. Key the transmitter to 100 watts output and adjust the REF trimpot R71 until the display shows reflected power of `REF=100` watts. The forward meter (yes, the forward meter) also should indicate 100 watts; the reflected meter is at full scale.
12. Press the [TUNE] button to end calibration.
13. Turn off the power to the tuner and the transmitter.
14. Remove the transmitter/wattmeter and the 50-ohm dummy load from the tuner.
15. Secure the cover back onto the tuner.
16. Connect your transmitter to the TRANSMITTER connector and connect your antenna to the appropriate antenna connector on the tuner.

Frequency Counter Calibration

To calibrate the frequency counter, you will need a transmitter, a 50-ohm dummy load, two 50-ohm SO-239 coax cables, a Phillips screwdriver, and a tuning tool or small flat blade screwdriver.

WARNING: Do not touch anything inside the tuner during operation! Serious, painful RF burns can result.

WARNING: Never operate the MFJ-993B with its cover removed; dangerous voltages and currents can be present during operation. Never exceed tuner specifications.

1. Turn off the power to the tuner and the transmitter.
2. Remove the cover from the tuner (12 screws) with a Phillips screwdriver.
3. Connect the 50-ohm dummy load to the ANTENNA 1 connector; connect the transmitter to the TRANSMITTER connector on the tuner.
4. Turn on the power to the transmitter. Set and lock the frequency to *exactly* 29.000 MHz.
5. Press and hold *both* the [C-DN] and [L-DN] buttons while turning the tuner power on. Both meter needles will go to full scale and a message `CAL FREQ 29.000` will display.
6. Key the transmitter to output about 10 watts. Adjust trimmer capacitor C118 (located between the two big integrated circuits) until the tuner displays a frequency of `29.000` MHz and the meter needles settle at the 0 watt marks. Notice the meter movement is exaggerated for easier calibration. Nominal tolerance of the frequency counter is ± 1 kHz.
7. Turn off the power to the tuner and the transmitter.
8. Secure the cover back onto the tuner.

Alinco Radio Interface

The MFJ-5124A radio interface allows users of EDX-2 compatible Alinco transceivers to connect to the MFJ-993B *IntelliTuner*™ Automatic Antenna Tuner. With this interface, power and control signals are connected between the radio and the tuner. The operator can then control the tuner with a single push of the [TUNE] button on the front panel of the radio. Supported Alinco radios are DX-70, DX-77, DX-701, DX-801, and any Alinco radio that supports the Alinco EDX-2 tuner.

Connections

1. Insert the 3.5 mm stereo phone plug into the tuner's RADIO INTERFACE jack.
2. Insert the 2.1 x 5.5 mm coaxial power plug into the tuner's POWER jack.
3. **Important:** *Make sure the DC power to the radio has been turned off. The radio does not fuse the DC power to the tuner, and damage to the radio can occur if the interface's power connection comes in contact with ground.*
4. Connect the 5-pin molex connector to the mating 5-pin molex connector, marked as ACC, on the back of the Alinco radio.
5. Push the [POWER] button on the tuner to the *in* position and then power on the radio.

Operation

The operation of the MFJ-5124A radio interface is similar to the operation of the EDX-2 described in the Alinco operating manual.

1. Push the [TUNE] button on the radio to initiate automatic tuning process; for DX-70 press [FUNC] then [TUNE]. The radio will automatically switch to CW mode, transmit a 10-watt carrier, and start the tuning process. "TUNE" appears in the radio's LCD while tuning; do not change the frequency or mode while tuning. When the tuning process is completed, the radio will stop transmitting, return to its previous mode and power setting; "TUNE" disappears.

Note the [TUNE] button on the tuner will also key the Alinco radio interface.

Icom Radio Interface

The MFJ-5124I radio interface allows users of AH-3 or AH-4 compatible Icom transceivers to connect to the MFJ-993B IntelliTuner™ Automatic Antenna Tuner. With this interface, power and control signals are connected between the radio and the tuner. The operator can then control the tuner with a single push of the [TUNER] button on the front panel of the radio. Supported Icom radios are IC-706, IC-707, IC-718, IC-728, IC-736, IC-738, IC-746, IC-756, IC-7000, and any Icom radio that supports the Icom AH-3 or AH-4 tuner.

Note: *The KEY connection of the MFJ-993B RADIO INTERFACE jack is an open-collector output, and it is safe to use with the IC-7000.*

Connections

1. Insert the 3.5 mm stereo phone plug into the tuner's RADIO INTERFACE jack.
2. Insert the 2.1 x 5.5 mm coaxial power plug into the tuner's POWER jack.
3. **Important:** *Make sure the DC power to the radio has been turned off. The radio does not fuse the DC power to the tuner, and damage to the radio can occur if the interface's power connection comes in contact with ground.*
4. Connect the 4-pin molex connector to the mating 4-pin molex connector, marked as TUNER, on the back of the Icom radio.
5. Push the [POWER] button on the tuner to the *in* position and then power on the radio.
6. Some Icom radios, such as the IC-706, automatically check to see if an external antenna tuner is connected during power on. For other Icom radios, such as the IC-718, the Tuner Type menu in the radio menu system must be enabled. Refer to your radio's operating manual for accessing the menu system and preparing the AH-4 antenna tuner operation. Use IC-718 as an example:
 - a. Push [PWR] for 1 second to turn power off.
 - b. While pushing and holding [SET], push [PWR] to turn power on.
 - c. Push [UP] or [DN] one or more times to select TUNER.
 - d. Rotate the Main Dial to select "4" for AH-4 antenna tuner.
 - e. Push [PWR] for one second to turn power off.
 - f. Push [PWR] to turn power on again.

Operation

The operation of the MFJ-5124I radio interface is similar to the operation of the AH-3 or AH-4 described in the Icom radio's operating manual.

1. Push and hold the [TUNER] button on the radio for one or two seconds to initiate automatic tuning process. The radio will automatically switch to CW mode, transmit a 10-watt carrier, and start the tuning process. When the tuning process is completed, the radio will stop transmitting, return to its previous mode and power setting.
2. Push the [TUNER] button on the radio quickly to bypass the tuner or to cancel tuning in progress.

Note the [TUNE] button on the tuner will also key the Icom radio interface.

Kenwood Radio Interface

The MFJ-5124K radio interface allows users of AT-300 compatible Kenwood transceivers to connect to the MFJ-993B *IntelliTuner*™ Automatic Antenna Tuner. With this interface, power and control signals are connected between the radio and the tuner. The operator can then control the tuner with a single push of the [AT TUNE] button on the front panel of the radio. Supported Kenwood radios are TS-50S, TS-450S, TS-480HX, TS-570S, TS-590S, TS-690S, TS-850S, TS-870S, TS-2000, and any Kenwood radio that supports the Kenwood AT-300 tuner.

Note: *The TS-480HX will automatically reduce its TX power to 100 watts maximum (25 watts AM) when the radio interface is used.*

Connections

1. Insert the 3.5 mm stereo phone plug into the tuner's RADIO INTERFACE jack.
2. Insert the 2.1 x 5.5 mm coaxial power plug into the tuner's POWER jack.
3. Insert the 8-pin modular plug into the MFJ-5124's TO RADIO jack.
4. **Important:** *Make sure the DC power to the radio has been turned off. The radio does not fuse the DC power to the tuner, and damage to the radio can occur if the interface's power connection comes in contact with ground.*
5. Connect the 6-pin molex connector to the mating 6-pin molex connector, marked as AT or ACC, on the back of the Kenwood radio.
6. Push the [POWER] button on the tuner to the *in* position and then power on the radio.
7. Some Kenwood radios automatically check to see if an external antenna tuner is connected during power on. For other Kenwood radios, such as the TS-450S and the TS-690S, the External Antenna Tuner menu in the radio menu system must be enabled. Refer to your radio's operating manual for accessing the menu system and preparing the AT-300 external antenna tuner operation. Use TS-450S and TS-690S as an example:
 - a. Press and hold the [ENT] key while turning the power on.
 - b. Rotate the [M.CH/VFO CH] control to select menu number 01 on the display.
 - c. Press the [UP] or [DOWN] key to change the setting to "ON."
 - d. Press the [CLR] key to return to normal operation.

Operation

The operation of the MFJ-5124K radio interface is similar to the operation of the AT-300 described in the Kenwood radio's operating manual.

1. Press and hold the [AT TUNE] button on the radio for one second to initiate automatic tuning process. The radio will automatically switch to CW mode, transmit a 10-watt carrier, and start the tuning process. When the tuning process is completed, the radio will stop transmitting, return to its previous mode and power setting.
2. Press the [AT TUNE] button on the radio quickly to bypass the tuner (some Kenwood radios, such as the TS-690S, do not have this bypass function) or to cancel tuning in progress.

Note the [TUNE] button on the tuner will not operate the Kenwood radio interface.

Yaesu Radio Interface/MFJ-5124Y

The MFJ-5124Y radio interface allows users of FC-30 compatible Yaesu transceivers to connect to the MFJ-993B IntelliTuner™ Automatic Antenna Tuners. With this interface, power and control signals are connected between the radio and the tuner. The operator can then control the tuner with a single push of the (TUNE) key on the front panel of the radio. Supported Yaesu radios are FT-100, FT-450, FT-857, FT-897, FT-950, and any Yaesu radio that supports the Yaesu FC-30 tuner.

Connections for FT-100

1. Before connecting the MFJ-5124Y to your radio, follow the instructions in the radio's manual for installing the FC-20 automatic antenna tuner.
 - a. Press and hold the [FUNC] key for ½ second to activate the Menu mode.
 - b. Rotate the [SELECT] knob to recall Menu #61 [TUNER/ATAS], and then rotate the Main Dial to change the setting to “tunEr.”
 - c. Press the [FUNC] key momentarily to save the new setting and exit to normal operation.
 - d. Turn the FT-100's power off, then on again, to re-initialize the radio regarding the tuner status.
2. Turn the radio off.
3. Insert the 3.5 mm stereo phone plug into the tuner's RADIO INTERFACE jack.
4. Insert the 2.1 x 5.5 mm coaxial power plug into the tuner's POWER jack.
5. Insert the 8-pin modular plug into the MFJ-5124's TO RADIO jack.
6. **Important:** *Make sure the DC power to the radio has been turned off. The radio does not fuse the DC power to the tuner, and damage to the radio can occur if the interface's power connection comes in contact with ground.*
7. Connect the 8-pin mini DIN connector to the mating 8-pin mini DIN connector at the end of the BAND DATA cable pigtail on the back of the radio.
8. Push the [POWER] button on the tuner to the *in* position and then power on the radio.

Operation for FT-100

The operation of the MFJ-5124Y radio interface is similar to the operation of the FC-20 described in the Yaesu radio's operating manual.

1. Press the [FUNC] key, as needed, to recall Operating Function Row 7 [MTR, TUN, PRO, VOX].
2. Press the [B](TUN) key on the radio for ½ second to turn the external tuner function on; the “TUN” icon will appear bolded in the radio's display.
3. Press and hold the [B](TUN) key on the radio to begin automatic tuning. The radio will automatically transmit a low-power carrier and start the tuning process. Press the [B](TUN) key again to cancel tuning in progress. When tuning is completed, the radio will stop transmitting and you will be ready for operation on this frequency.

Note the [TUNE] button on the tuner will not operate the MFJ-5124Y Yaesu radio interface.

Connections for FT-450

1. Before connecting the MFJ-5124Y to your radio, follow the instructions in the radio's manual for installing the FC-30/-40 automatic antenna tuner.
 - a. Press and hold the [F] button for one second to enter the Menu mode. The "MENU" icon will appear in the display.
 - b. Rotate the [DSP/SEL] knob to select Menu item [TUNER (TUNER/ATAS)].
 - c. Press the [DSP/SEL] knob to enable this selected Menu item.
 - d. Rotate the [DSP/SEL] knob to change the setting to "EXT ATU."
 - e. Press and hold the [F] button for one second to save the new setting and exit to normal operation.
2. Turn the radio off.
3. Insert the 3.5 mm stereo phone plug into the tuner's RADIO INTERFACE jack.
4. Insert the 2.1 x 5.5 mm coaxial power plug into the tuner's POWER jack.
5. Insert the 8-pin modular plug into the MFJ-5124's TO RADIO jack.
6. **Important:** *Make sure the DC power to the radio has been turned off. The radio does not fuse the DC power to the tuner, and damage to the radio can occur if the interface's power connection comes in contact with ground.*
7. Connect the 8-pin mini DIN connector to the mating 8-pin mini DIN connector, marked as TUNER, on the back of the radio.
8. Push the [POWER] button on the tuner to the *in* position and then power on the radio.

Operation for FT-450

The operation of the MFJ-5124Y radio interface is similar to the operation of the FC-30/-40 described in the Yaesu radio's operating manual.

1. Press the (TUNE) button on the radio briefly to enable the external tuner function. The "TUNER" icon will appear in the radio's display. If the radio frequency is out of the amateur band, the "TUNER" icon will not appear.
2. Press and hold the (TUNE) button on the radio for one second to begin automatic tuning. The radio will automatically transmit a low-power carrier and start the tuning process. The "TUNER" icon will blink while tuning is in progress. Press and hold the (TUNE) button on the radio for one second while tuning is in progress to cancel the automatic tuning.
3. When tuning is completed, the radio will stop transmitting and you will be ready for operation on this frequency.

Note the [TUNE] button on the tuner will not operate the MFJ-5124Y Yaesu radio interface.

Connections for FT-857 or FT-897

1. Before connecting the MFJ-5124Y to your radio, follow the instructions in the radio's manual for installing the FC-30 automatic antenna tuner. For the following, use the [FUNC] key and the [SELECT] knob on the FT-857, or use the [F] key and the [MEM/VFO CH] knob on the FT-897.
 - a. Press and hold the [FUNC] or [F] key for one second to activate the Menu mode.
 - b. Rotate the [SELECT] or [MEM/VFO CH] knob to recall Menu Mode #001 [EXT MENU], and then rotate the Main Dial to change the setting to "ON" to enable extended Menu Mode.
 - c. Rotate the [SELECT] or [MEM/VFO CH] knob to recall Menu Mode #020 [CAT/LIN/TUN], and then rotate the Main Dial to change the setting to "TUNER."
 - d. Press and hold the [FUNC] or [F] key for one second to save the new setting and exit to normal operation.
 - e. Turn the radio off, then on again. Do not connect the MFJ-5124Y before changing the Menu Mode #020 [CAT/LIN/TUN].
 - f. Press and hold the [FUNC] or [F] key for one second to activate the Menu mode.
 - g. Rotate the [SELECT] or [MEM/VFO CH] knob to recall Menu Mode #085 [TUNER/ATAS], and then rotate the Main Dial to change the setting to "TUNER."
 - h. Press and hold the [FUNC] or [F] key for one second to save the new settings and exit to normal operation.
2. Turn the radio off. Insert the 3.5 mm stereo phone plug into the tuner's RADIO INTERFACE jack.
3. Insert the 2.1 x 5.5 mm coaxial power plug into the tuner's POWER jack.
4. Insert the 8-pin modular plug into the MFJ-5124's TO RADIO jack.
5. **Important:** *Make sure the DC power to the radio has been turned off. The radio does not fuse the DC power to the tuner, and damage to the radio can occur if the interface's power connection comes in contact with ground.*
6. Connect the 8-pin mini DIN connector to the mating 8-pin mini DIN connector, marked as CAT/LINEAR, on the back of the radio.
7. Push the [POWER] button on the tuner to the *in* position and then power on the radio.

Operation for FT-857 or FT-897

The operation of the MFJ-5124Y radio interface is similar to the operation of the FC-30 described in the Yaesu radio's operating manual.

1. Press the [FUNC] or [F] key, then rotate the [SELECT] or [MEM/VFO CH] knob to recall Multi Function Row "k" [TUNE, DOWN, UP].
2. Press the [A](TUNE) key on the radio to turn the external tuner function on; the "TUNE" or "TUNR" icon will appear in the radio's display.
3. Press and hold the [A](TUNE) key on the radio to begin automatic tuning. The radio will automatically transmit a low-power carrier and start the tuning process. Press the [A](TUNE) key again to cancel tuning in progress. When tuning is completed, the radio will stop transmitting and you will be ready for operation on this frequency.

Note the [TUNE] button on the tuner will not operate the MFJ-5124Y Yaesu radio interface.

Connections for FT-950

1. Before connecting the MFJ-5124Y to your radio, follow the instructions in the radio's manual for installing the FC-40 automatic antenna tuner.
 - a. Press the [MENU] button momentarily to enter the Menu mode.
 - b. Rotate the [SELECT] knob to select Menu item [110 TGEN EXT TUN]. Press the [SELECT] knob momentarily to toggle the display between [110 TGEN] and [EXT TUN].
 - c. Rotate the [CLAR/VFO-B] knob to change the setting to "Etu" to enable the External Tuner.
 - d. Press and hold the [MENU] button for one second to save the new setting and exit to normal operation. If you only *momentarily* press the [MENU] button, the new setting will not be retained.
2. Turn the radio off.
3. Insert the 3.5 mm stereo phone plug into the tuner's RADIO INTERFACE jack.
4. Insert the 2.1 x 5.5 mm coaxial power plug into the tuner's POWER jack.
5. Insert the 8-pin modular plug into the MFJ-5124's TO RADIO jack.
6. **Important:** *Make sure the DC power to the radio has been turned off. The radio does not fuse the DC power to the tuner, and damage to the radio can occur if the interface's power connection comes in contact with ground.*
7. Connect the 8-pin mini DIN connector to the mating 8-pin mini DIN connector, marked as TUNER, on the back of the radio.
8. Push the [POWER] button on the tuner to the *in* position and then power on the radio.

Operation for FT-950

The operation of the MFJ-5124Y radio interface is similar to the operation of the FC-40 described in the Yaesu radio's operating manual.

1. Press the (TUNE) button on the radio briefly to enable the external tuner function. The "TUNER" icon will appear in the radio's display.
2. Press and hold the (TUNE) button on the radio for one second to begin automatic tuning. The radio will automatically transmit a low-power carrier and start the tuning process. The "TUNER" icon will blink while tuning is in progress. Press the (TUNE) button on the radio while tuning is in progress to cancel the automatic tuning.

Note: *The FT-950 will not start automatic tuning when the SWR is greater than approximately 5:1, indicated by both "TUNER" and "HI-SWR" icons blinking once when the (TUNE) button on the radio is pressed and held for one second.*

3. When tuning is completed, the radio will stop transmitting and you will be ready for operation on this frequency.

Note the [TUNE] button on the tuner will not operate the MFJ-5124Y Yaesu radio interface.

Yaesu Radio Interface/MFJ-5124Y2

The MFJ-5124Y2 radio interface allows users of Yaesu FT-847 and transceivers with compatible CAT system to connect to the MFJ-993B *IntelliTuner*™ Automatic Antenna Tuner. With this interface, control signals are connected between the radio and the tuner. With this cable the operator can control the tuner and radio with a single push of the [TUNE] button on the front panel of the MFJ-993B.

Connections for FT-847

1. Before connecting the MFJ-5124 to your radio, setup the radio's CAT.
 - a. Press the [MENU] key momentarily to activate the Menu mode.
 - b. Rotate the [SUB-TUNE] knob to recall Menu #37 [CAT RATE], and then rotate the [MEM/VFO CH] knob to change the setting to "4800."
 - c. Press the [MENU] key momentarily to save the new setting and exit to normal operation.
2. Turn the radio off.
3. Insert the 3.5 mm stereo phone plug into the tuner's RADIO INTERFACE jack.
4. Insert the 2.1 x 5.5 mm coaxial power plug into the tuner's POWER jack.
5. Insert the 8-pin modular plug into the MFJ-5124's TO RADIO jack.
6. **Important:** *Make sure the DC power to the radio has been turned off.*
7. Connect the DB-9 connector to the mating DB-9 connector, marked as CAT, on the back of the radio.
8. The FT-847 does not have a DC power connection on its CAT port. Connect a 12 volts DC 1000 mA power supply, such as the MFJ-1316, to the MFJ-5124's POWER jack. This will supply power to the MFJ-5124 and the MFJ-993B.

Operation for FT-847

The operation of the MFJ-5124Y2 CAT interface is simple.

1. Turn on the radio, and then turn on the tuner.
2. Press and hold the [TUNE] button on the tuner for 0.5 to 2 seconds to start the automatic tuning. The radio will switch to AM mode, transmit a carrier, and start the tuning process. When the tuning process is completed, the radio will stop transmitting and return to its previous mode. Press the [TUNE] button on the tuner briefly will place the tuner into bypass mode.

Note the (TUNE) key on the radio will not operate the Yaesu radio's CAT interface.

Yaesu Radio Interface/MFJ-5124Y3

The MFJ-5124Y3 radio interface allows users of Yaesu FT-1000MP series and FTDX-9000 series transceivers to connect to the MFJ-993B *IntelliTuner*™ Automatic Antenna Tuner. With this interface, control signals are connected between the radio and the tuner. With this cable the operator can control the tuner and radio with a single push of the [TUNE] button on the front panel of the MFJ-993B.

Connections for FT-1000MP series of radios

1. Before connecting the MFJ-5124Y3 to your radio, set the maximum TUNE power of the radio as follows:
 - a. On your transceiver, enter the Menu mode by pressing and holding the [FAST] key and then pressing [ENT].
 - b. Rotate the [MEM/VFO CH] knob until you see menu 4-3 on the transceiver's CH display.
 - c. Rotate the [MAIN VFO] knob to select 50 for 100-watt radios (FT-1000MP/MP Field) or 75 for the FT-1000MP MKV when an amplifier will be used. This gives the best SWR accuracy, which may be important for solid-state amplifiers. When an amplifier is not used, the setting can be set at 10 for all transceivers.
 - d. Press [ENT] to exit the Menu mode.
2. Insert the 3.5 mm stereo phone plug into the MFJ-993B RADIO INTERFACE jack.
3. Connect the 3.5 mm mono plug on the MFJ-5124Y3 to the REMOTE jack on the rear panel of the transceiver.
4. Connect a 12V 1000 mA DC source to the MFJ-993B.
5. Push the [POWER] button on the MFJ-993B to the *in* position. The radio may be powered on either before or after the tuner is powered on.

Operation for FT-1000MP series of radios

The transceiver is controlled by the MFJ-993B. To operate:

1. Press the [TUNE] button on the MFJ-993B for ½-2 seconds to initiate the tuning process. The radio will automatically transmit a low-power carrier and start the tuning process. When tuning is completed, the radio will stop transmitting and you will be ready for operation on this frequency.

Connections for FTDX-9000 series of radios

1. Before connecting the MFJ-5124Y3 to your radio, set the maximum TUNE power of the radio as follows:
 - a. On your transceiver, enter the Menu mode by pressing the [MNU] key momentarily.
 - b. Rotate the Main Tuning Dial knob until you see menu item [157 EXT AMP TUNING PWR] on the transceiver's display.
 - c. Rotate the [CLAR/VFO-B] knob to select 50 watts for best SWR accuracy. The TUNE power varies with the output power level control setting, so ensure that the TUNE power is somewhere between 20-50 watts.

- d. Press and hold in the [MNU] key for two seconds to save the new setting and exit to normal operation. If you press the [MNU] key momentarily, the new setting will *not* be saved.
2. Insert the 3.5 mm stereo phone plug into the MFJ-993B RADIO INTERFACE jack.
3. Connect the 3.5-mm mono plug on the MFJ-5124Y3 to the REMOTE jack on the rear panel of the transceiver.
4. Connect a 12V 1000 mA DC source to the MFJ-993B.
5. Push the [POWER] button on the MFJ-993B to the *in* position. The radio may be powered on either before or after the tuner is powered on.

Operation for FTdx-9000 series of radios

The transceiver is controlled by the MFJ-993B. To operate:

1. Press the [TUNE] button on the MFJ-993B for ½-2 seconds to initiate the tuning process. The radio will automatically transmit a low-power carrier and start the tuning process. When tuning is completed, the radio will stop transmitting and you will be ready for operation on this frequency.

Yaesu Radio Interface/MFJ-5124Y4

The MFJ-5124Y4 radio interface allows users of Yaesu FT-2000 series and FTdx-5000 series transceivers to connect to the MFJ-993B *IntelliTuner*[™] Automatic Antenna Tuner. With this interface, control signals are connected between the radio and the tuner. The operator can then control the tuner and radio with a single push of the [TUNE] button on the front panel of the MFJ-993B.

Connections for FT-2000 series of radios

1. Before connecting the MFJ-5124Y4 to your radio, set the maximum TUNE power of the radio as follows:
 - a. On your transceiver, enter the Menu mode by pressing the [MENU] key momentarily.
 - b. Rotate the Main Tuning Dial knob until you see menu item [145 tGEN TUN PWR] on the transceiver's display.
 - c. Rotate the [SUB VFO-B] knob to select 20 watts for best SWR accuracy. For the FT-2000D, we recommend that this be set to 50 watts if the user normally operates at 100 watts output power (when power is turned down to 100 watts, the TUNE power will reduce to 25 watts). If the operator normally has his FT-2000D set for the full 200 watts, then this should be set to 20 watts.
 - d. Press and hold in the [MENU] key for two seconds to save the new setting and exit to normal operation. If you press the [MENU] key momentarily, the new setting will *not* be saved.
2. Insert the 3.5 mm stereo phone plug into the MFJ-993B RADIO INTERFACE jack.
3. Connect the RCA plug on the MFJ-5124Y4 to the TX REQ jack on the rear panel of the transceiver.
4. Connect a 12V 1000 mA DC source to the MFJ-993B.
5. Push the [POWER] button on the MFJ-993B to the *in* position. The radio may be powered on either before or after the tuner is powered on.

Operation for FT-2000 series of radios

The transceiver is controlled by the MFJ-993B. To operate:

1. Press the [TUNE] button on the MFJ-993B for ½-2 seconds to initiate the tuning process. The radio will automatically transmit a low-power carrier and start the tuning process. When tuning is completed, the radio will stop transmitting and you will be ready for operation on this frequency.

Connections for FTDX-5000 series of radios

1. Before connecting the MFJ-5124Y4 to your radio, set the maximum TUNE power of the radio as follows:
 - a. On your transceiver, enter the Menu mode by pressing the [MENU] button momentarily.
 - b. Rotate the (VFO-A)[SELECT] knob until you see menu item [173 TGEN TUN PWR] on the transceiver's display.
 - c. Rotate the (VFO-B)[SELECT] knob to select 20 watts for best SWR accuracy. For the FTDX-5000, we recommend that this be set to 50 watts if the user normally operates at 100 watts output power (when power is turned down to 100 watts, the TUNE power will reduce to 25 watts). If the operator normally has his FTDX-5000 set for the full 200 watts, then this should be set to 20 watts.
 - d. Press and hold in the [MENU] button for two seconds to save the new setting and exit to normal operation. If you press the [MENU] button momentarily, the new setting will *not* be saved.
2. Insert the 3.5 mm stereo phone plug into the MFJ-993B RADIO INTERFACE jack.
3. Connect the RCA plug on the MFJ-5124Y4 to the TX REQ jack on the rear panel of the transceiver.
4. Connect a 12V 1000 mA DC source to the MFJ-993B.
5. Push the [POWER] button on the MFJ-993B to the *in* position. The radio may be powered on either before or after the tuner is powered on.

Operation for FTDX-5000 series of radios

The transceiver is controlled by the MFJ-993B. To operate:

1. Press the [TUNE] button on the MFJ-993B for ½-2 seconds to initiate the tuning process. The radio will automatically transmit a low-power carrier and start the tuning process. When tuning is completed, the radio will stop transmitting and you will be ready for operation on this frequency.

In Case of Difficulty

If the LCD screen is blank, check adjustment of the contrast control. If no audio is present (with audio enabled) adjust the volume control.

If the tuner acts erratic, reset the tuner to factory defaults by pressing both the [TUNE] and [L-DN] buttons while turning the power on.

If the tuner fails to tune, please **double check** all connections and follow the tuning procedures again. Be sure you are using *enough inductance* (through manual adjustment) and *minimum capacitance*.

If the tuner arcs at the rated power levels, please **double check** all connections and follow the tuning procedures again. Ensure you are not exceeding the tuner's rated power handling capability. Be sure you are using the *least amount of inductance* and the *greatest capacitance* possible that still allows matching the load on the operating frequency.

Note: If the tuner arcs when operating on the 160-meter band, it may be necessary to reduce transmitter output power.

If you are still unsuccessful, but the tuner does adjust and operate when used with a dummy load or another antenna, please read "Grounding Hints" on page 23 and "Antenna System Hints" on page 24.

Technical Assistance

If you have any problem with this unit first check the appropriate section of this manual. If the manual does not reference your problem or your problem is not solved by reading the manual, you may call *MFJ Technical Service* at 662-323-0549 or the *MFJ Factory* at 662-323-5869. You will be best helped if you have your unit, manual and all information on your station handy so you can answer any questions the technicians may ask.

You can also send questions by mail to MFJ Enterprises, Inc., 300 Industrial Park Road, Starkville, MS 39759; by facsimile (FAX) to 662-323-6551; or by email to techinfo@mfjenterprises.com. Send a complete description of your problem, an explanation of exactly how you are using your unit, and a complete description of your station. Also include the firmware version number of your unit.

List of Accessories

- **MFJ-993RC:** Remote control
- **MFJ-1316:** 12 VDC 1.5 amp power supply
- **MFJ-5124A:** Interface cable for compatible Alinco radios
- **MFJ-5124I:** Interface cable for compatible Icom radios
- **MFJ-5124K:** Interface cable for compatible Kenwood radios
- **MFJ-5124Y:** Interface cable for Yaesu FT-100, FT-450, FT-857, FT-897, and FT-950
- **MFJ-5124Y2:** Interface cable for Yaesu FT-847 and compatible radios
- **MFJ-5124Y3:** Interface cable for Yaesu FT-1000MP series and FTDX-9000 series
- **MFJ-5124Y4:** Interface cable for Yaesu FT-2000 series and FTDX-5000 series
- **MFJ-5409:** 6 feet long RS-232 cable, female DB-9 to male DB9 connector
- **MFJ-5803:** 3 feet long RG-58 A/U 50-ohm coax cable with a PL-259 connector on each end
- **MFJ-5806:** 6 feet long RG-58 A/U 50-ohm coax cable with a PL-259 connector on each end
- **MFJ-5818:** 18 feet long RG-58 A/U 50-ohm coax cable with a PL-259 connector on each end

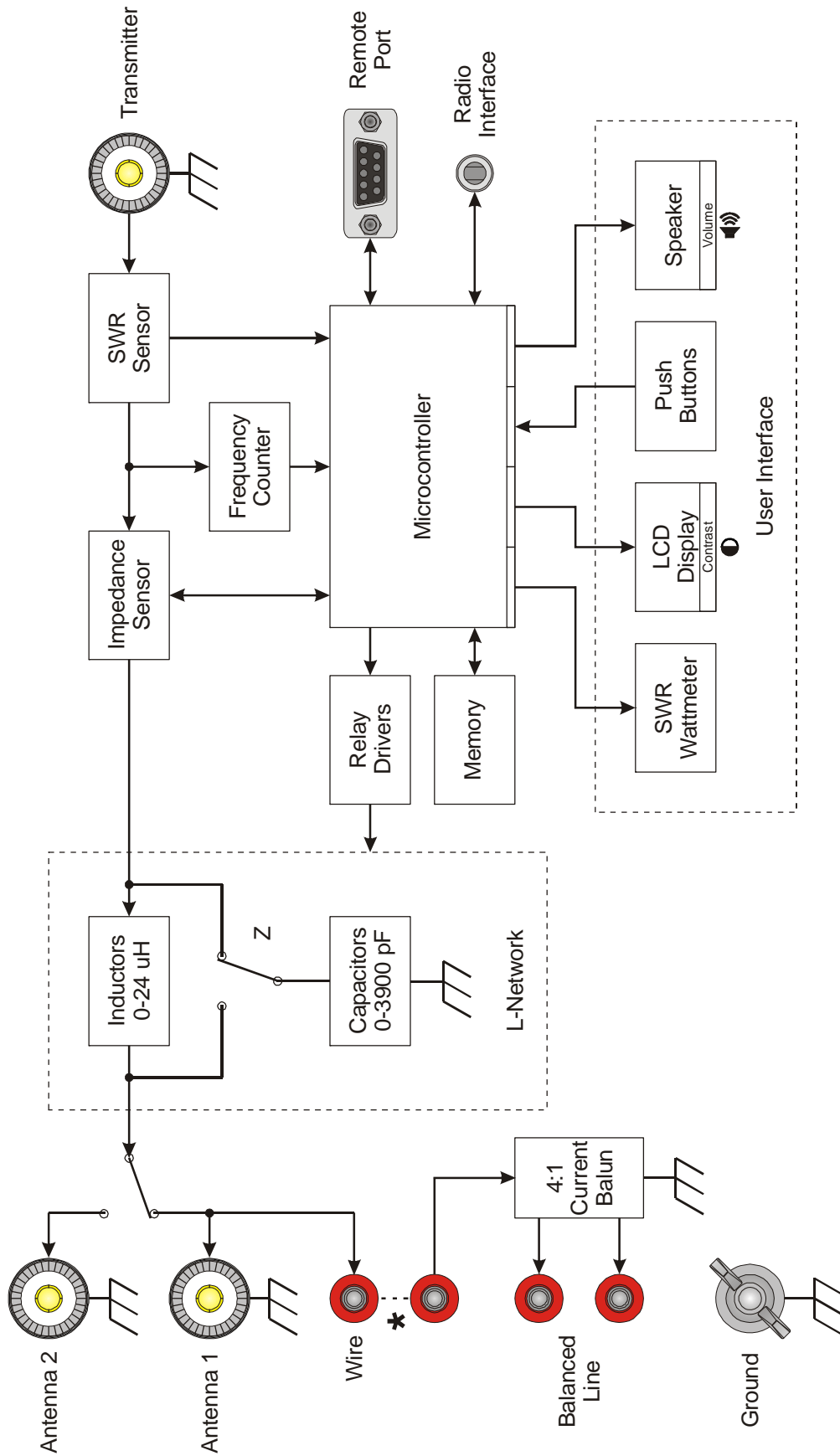

Figure 16. MFJ-993B Circuit Block Diagram.

LIMITED 12 MONTH WARRANTY

MFJ Enterprises, Inc. warrants to the original owner of this product, if manufactured by MFJ Enterprises, Inc. and purchased from an authorized dealer or directly from MFJ Enterprises, Inc. to be free from defects in material and workmanship for a period of 12 months from date of purchase provided the following terms of this warranty are satisfied.

1. The purchaser must retain the dated proof-of-purchase (bill of sale, canceled check, credit card or money order receipt, etc.) describing the product to establish the validity of the warranty claim and submit the original or machine reproduction of such proof of purchase to MFJ Enterprises, Inc. at the time of warranty service. MFJ Enterprises, Inc. shall have the discretion to deny warranty without dated proof-of-purchase. Any evidence of alteration, erasure, or forgery shall be cause to void any and all warranty terms immediately.
2. MFJ Enterprises, Inc. agrees to repair or replace at MFJ's option without charge to the original owner any defective product under warrantee provided the product is returned postage prepaid to MFJ Enterprises, Inc. with a personal check, cashiers check, or money order for **\$12.00** covering postage and handling.
3. This warranty is **NOT** void for owners who attempt to repair defective units. Technical consultation is available by calling the Service Department at 662-323-0549 or the MFJ Factory at 662-323-5869.
4. This warranty does not apply to kits sold by or manufactured by MFJ Enterprises, Inc.
5. Wired and tested PC board products are covered by this warranty provided **only the wired and tested PC board product is returned**. Wired and tested PC boards installed in the owner's cabinet or connected to switches, jacks, or cables, etc. sent to MFJ Enterprises, Inc. will be returned at the owner's expense unrepaired.
6. Under no circumstances is MFJ Enterprises, Inc. liable for consequential damages to person or property by the use of any MFJ products.
7. **Out-of-Warranty Service:** MFJ Enterprises, Inc. will repair any out-of-warranty product provided the unit is shipped prepaid. All repaired units will be shipped COD to the owner. Repair charges will be added to the COD fee unless other arrangements are made.
8. This warranty is given in lieu of any other warranty expressed or implied.
9. MFJ Enterprises, Inc. reserves the right to make changes or improvements in design or manufacture without incurring any obligation to install such changes upon any of the products previously manufactured.
10. All MFJ products to be serviced in-warranty or out-of-warranty should be addressed to:

**MFJ Enterprises, Inc.
300 Industrial Park Road
Starkville, Mississippi 39759 USA**

and must be accompanied by a letter describing the problem in detail along with a copy of your dated proof-of-purchase.

11. This warranty gives you specific rights, and you may also have other rights which vary from state to state.



MFJ ENTERPRISES, INC.
300 Industrial Park Road
Starkville, MS 39759

MFJ-993B Manual
Version 2B
Printed In U.S.A. 03/2012